





















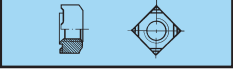
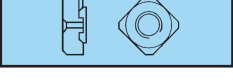







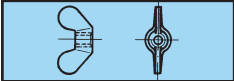





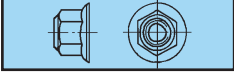
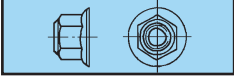
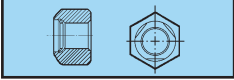

Nuts/Muttern

Page/Seite

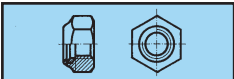
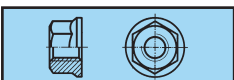
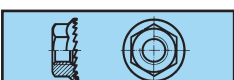
	DIN 934 CI/KI 8 Plain/unbeh	8:1
	DIN 934 CI/KI 8 Zincpl/verz	8:2
	DIN 934 CI/KI 6 Plain/unbeh Zincpl/verz	8:3
	DIN 934 CI/KI 8 HDG/feuerverz	8:3
	DIN 934 CI/KI 8 Yellow ZPL/gelbverz	8:4
	Blackoxide/schwarzoxid Dacromet	8:4
	DIN 934 CI/KI 8 Leftthreaded/Linksgewinde Plain/unbeh Zincpl/verz	8:4
	DIN 934 CI/KI 6 Fine pitch/Feingewinde Plain/unbeh Zincpl/verz	8:5
	DIN 934 CI/KI 8 Fine pitch/Feingewinde Plain/unbeh Zincpl/verz	8:5
	ISO 4032 CI/KI 8 Plain/unbeh Zincpl/verz HDG/feuerverz	8:6
	Zinc-iron black waxed/zinc-Eisen schwarz bewachst	8:6
	ISO 4032 CI/KI 10 Plain/unbeh Dacromet	8:6
	DIN 934 CI/KI 10 CI/KI 12	8:7
	DIN 934 CI/KI 10 Fine pitch/Feingewinde	8:7
	ML6M Plain/unbeh Zincpl/verz	8:8
	DIN 439B Plain/unbeh Zincpl/verz	8:8
	DIN 936 Plain/unbeh Zincpl/verz	8:9
	Hex nut large key width/6-kant Mutter mit grosser Schlüsselweite Zincpl/verz	8:9
	DIN 439B Fine pitch/Feingewinde Plain/unbeh Zincpl/verz	8:10
	DIN 936 Fine pitch/Feingewinde Plain/unbeh Zincpl/verz	8:10
	DIN 936 Left threaded/Linksgewinde Plain/unbeh Zincpl/verz	8:11
	ISO 4035 Plain/unbeh Zincpl/verz	8:11
	DIN 929 Plain/unbeh	8:12
	DIN 928 Plain/unbeh UNC- UNF- thread/Gewinde	8:12
	FN Square weldnut with collar/4-kant Schweissmutter mit Führung Plain/unbeh	8:12
	FK4M Square weldnut/4-Kant Schweissmutter	8:13
	Spot-weldnut/Anpunktmutter Plain/unbeh	8:13
	DIN 315 Plain/unbeh Zincpl/verz	8:14
	Wingnut Amerikan type/Flügelmutter amerikanische Typ Zincpl/verz	8:14
	Wingnut Japanese type/Flügelmutter japanischer Typ Zincpl/verz	8:15













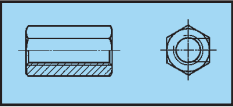

Nuts/Muttern

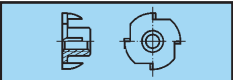
Page/Seite

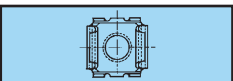
	Wingnut "DIN 315"/Flügelmutter "DIN 315" Zincpl/verz UNC-thread/UNC-gewinde	8:15
	Hex full nut/Sechskantmutter und UNC- UNF-thread/Gewinde Plain/unbeh Zincpl/verz HDG/feuerverz	8:16
	Hex full nut/Sechskantmutter UNC Left threaded/Linksgewinde Plain/unbeh Zincpl/verz	8:16
	DIN 1587 Plain/unbeh Zincpl/verz Turned dome/gedreht	8:17
	Hex domenut/hutmutter Japanese type/japanische Form Zincpl/verz	8:17
	Hexagon domed cap nuts/Sechskanthurmutter UNC-thread/ UNC-gewinde Zincpl/verz	8:17
	DIN 985 CI/KI 6 Zincpl/verz	8:18
	DIN 985 CI/KI 8 Zincpl/verz	8:18
	DIN 982 CI/KI 8 Zincpl/verz	8:19
	DIN 6924 CI/KI 8 Zincpl/verz	8:19
	DIN 985 CI/KI 6 Fine pitch/Feingewinde Zincpl/verz	8:20
	DIN 985 CI/KI 10 Fine pitch/Feingewinde Zincpl/verz	8:20
	DIN 985 CI/KI 10 Zincpl/verz	8:21
	DIN 6924 CI/KI 10 Zincpl/verz	8:21
	DIN 980 CI/KI 8 Zincpl/verz	8:22
	DIN 980 CI/KI 8 Zincpl/verz Fine pitch/Feingewinde	8:22
	DIN 6925 CI/KI 8 Zincpl/verz	8:23
	DIN 6926 CI/KI 8 Zincpl/verz	8:23
	DIN 6927 CI/KI 8 Zincpl/verz	8:24
	DIN 980 CI/KI 8 HDG/feuerverz	8:24
	DIN 986 Zincpl/verz	8:25
	Selflocking nylon ins./Locking Mutter UNC/UNF Zincpl/verz	8:25
	DIN 6923 CI/KI 8 Zincpl/verz	8:26
	DIN 6923 Flange nut with serration/Flangemutter mit Sperrzähnen CI/KI 8 Zincpl/verz	8:26
	Flangenut high/Fl.mutter hoch Zincpl/verz	8:26
	Castle nut/Kronenmutter DIN 935-1 CI/KI 6 Plain/unbeh Zincpl/verz	8:27
	Castle nut/Kronenmutter DIN 935-1 CI/KI 6 Fine pitch thread/ Feingewinde Zincpl/verz	8:27

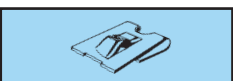
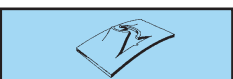
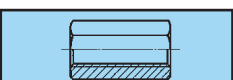
Nuts/Muttern

Page/Seite

	Square nut/Vierkantmutter DIN 557 Plain/unbeh Zincpl/verz	8:28
	Square nut/Vierkantmutter DIN 562 Plain/unbeh Zincpl/verz	8:28
	Hexnut/Sechskantmutter thin/Niedrige W-thread/W-gewinde Zincpl/verz	8:28
	Hexagon nut/Sechskantmutter (Langmutter) Plain/unbeh Zincpl/verz	8:29
	Coupling nut/Verbindungsmutter DIN 6334 Hexagon nut/Sechskantmutter UNC-thread/UNC-gewinde	8:29
	DIN 6330 A CI/KI 6	8:30
	DIN 6330 B CI/KI 6	8:30
	DIN 6330 B CI/KI 10	8:30
	DIN 6331 CI/KI 10	8:30
	Tee nut/Einschlagmutter Plain/unbeh Zincpl/verz	8:31
	DIN 466/DIN 467 Zincpl/verz	8:31
	Cage nut/Käfigmutter SMG MC and/und CV Zincpl/verz Yellow ZPL/gelbverz	8:32
	Speed nut/Schnappmutter for/für self tapping screw/Blechschauben SNU Plain/unbeh Zincpl/verz	8:33
	Speed nut/Schnappmutter for/für self tapping screw/Blechschauben SNJ, SNP and/und NU Plain/unbeh Zincpl/verz	8:34
	Speed nut for M-thread/Schnappmutter für M-gewinde/ NUT Zincpl/verz	8:35
	Hex distance nut/6-kant Distanzmutter Zincpl/verz	8:36, 8:37
	Round distance nut/rund Distanzmutter Zincpl/verz	8:38
	Pressnut KALEI®/Setzmutter KALEI® Case hardened/einsatzgehärtet Zincpl/verz	8:39
	Rivet nut/Nietmutter anchor ARB BN 196 Steel/Stahl Zincpl/verz	8:40

Nuts/Muttern

Page/Seite

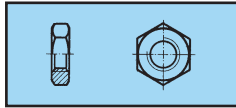

Hexagon thin nut/Sechskantmutter niedrige Form UNC-thread/
Gewinde Plain/unbeh Zincpl/verz HDG/feuerverz

8:41

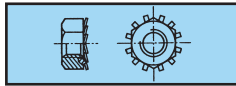

Combinut/Kombimutter with lock washers/mit Zahnscheiben

8:41



Self locking counter nut/Sicherungsmutter
DIN 7967 Plain/unbeh Zincpl/verz

8:42

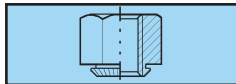

Pressnut/Setzmuttern BN 201 Zincpl/verz

8:42

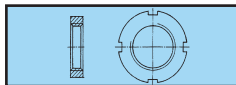

DIN 981

8:43

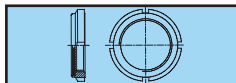

Locknut CRN/CRP

8:44



DIN 6915 CI/KI 10 Page/Seite 2:26-2:27

DIN 934

Steel/Stahl
Class/Klasse 8 Plain/unbeh

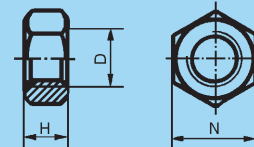

D	N	H	Price/Preis €/1000 pcs/St					
			Boxp./Kartonverp.		Bulk/Grosskartonverp.		Normalp./Standardverp.	
			Box quantity/Verp.	Price/Preis	Box quantity/Verp.	Price/Preis	Box quantity/Verp.	Price/Preis
M3	5,5	2,4	200	12	85000	8	1000	9
M3,5	6	2,8					500	11
M4	7	3,2	200	13	42000	10	1000	11
M5	8	4	200	15	26000	12	500	13
M6	10	5	200	20	13000	17	500	18
M7	11	5,5					500	48
M8	13	6,5	200	34	5700	29	500	31
M10	17	8	100	73	2700	67	200	69
M12	19	10	100	109	1700	95	200	96
M14	22	11					200	175
M16	24	13	50	219	850	190	100	198
M18	27	15					100	380
M20	30	16	25	449	430	410	50	424
M22	32	18					50	790
M24	36	19	25	876	240	810	50	840
M27	41	22					25	1760
M30	46	24					25	2160
M33	50	26					10	2610
M36	55	29					10	3700
M39	60	31					10	5650
M42	65	34					Bulk/Grossverp.	7650
M45	70	36					Bulk/Grossverp.	8910
M48	75	38					Bulk/Grossverp.	12700
M52	80	42					Bulk/Grossverp.	17100
M56	85	45					Bulk/Grossverp.	24300
M60	90	48					Bulk/Grossverp.	28800
M64	95	51					Bulk/Grossverp.	35100
M68	100	54					Bulk/Grossverp.	49000
M72x6	105	58					Bulk/Grossverp.	68000
M76x6	110	61					Bulk/Grossverp.	104000
M80x6	115	64					Bulk/Grossverp.	144000
M85x6	120	68					Bulk/Grossverp.	149000
M90x6	130	72					Bulk/Grossverp.	288000
M95x6	135	76					Bulk/Grossverp.	296000
M100x6	145	80					Bulk/Grossverp.	299000

Order ex./Best. ex.: DIN 934 Class/Klasse 8 M3 Plain/unbeh
Article ex./Artikelnr ex.: 9340030

DIN 934

Steel/Stahl
Class/Klasse 8 Zincpl/verz

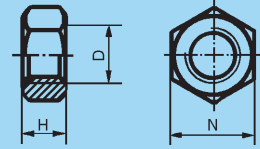

D	N	H	Price/Preis €/1000 pcs/St					
			Boxp./Kartonverp.		Bulk/Grosskartonverp.		Normalp./Standardverp.	
			Box quantity/Verp.	Price/Preis	Box quantity/Verp.	Price/Preis	Box quantity/Verp.	Price/Preis
M3	5,5	2,4	200	12	70000	9	1000	10
M3,5	6	2,8					1000	12
M4	7	3,2	200	14	32000	11	1000	12
M5	8	4	200	16	26000	13	500	14
M6	10	5	200	22	13000	18	500	19
M7	11	5,5					500	49
M8	13	6,5	200	36	5000	32	500	33
M10	17	8	100	79	2700	68	200	72
M12	19	10	100	128	1700	108	200	119
M14	22	11	100	197	1300	177	200	185
M16	24	13	50	253	800	215	100	230
M18	27	15	50	420			100	390
M20	30	16	25	498	400	460	50	470
M22	32	18					50	830
M24	36	19	25	930	240	865	50	890
M27	41	22					25	1953
M30	46	24					25	2400
M33	50	26					10	2900
M36	55	29					10	3900
M39	60	31					10	5900
M42	65	34					Bulk/Grossverp.	8500
M45	70	36					Bulk/Grossverp.	9900
M48	75	38					Bulk/Grossverp.	14100
M52	80	42					Bulk/Grossverp.	19000
M56	85	45					Bulk/Grossverp.	27000
M60	90	48					Bulk/Grossverp.	32000
M64	95	51					Bulk/Grossverp.	39000
M68	100	54					Bulk/Grossverp.	66000
M72x6	105	58					Bulk/Grossverp.	82000
M76x6	110	61					Bulk/Grossverp.	124000
M80x6	115	64					Bulk/Grossverp.	173000
M85x6	120	68					Bulk/Grossverp.	179000
M90x6	130	72					Bulk/Grossverp.	346000
M95x6	135	76					Bulk/Grossverp.	355000
M100x6	145	80					Bulk/Grossverp.	359000

Order ex./Best. ex.: DIN 934 Class/Klasse 8 M3 Zincpl/verz
Article ex./Artikelnr ex.: 93400301

DIN 934

Steel/Stahl Class/Klasse 6
Plain/unbeh Zincpl/verz

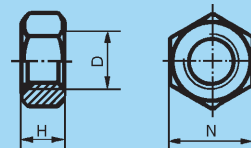

D	N	H	Box quantity/ Verpackung	Price/Preis €/1000 pcs/St	
				Plain/unbeh	Zincpl/verz
M1	2,5	0,8	100		489
M1,2	3	1,0	100		366
M1,4	3	1,2	100		312
M1,6	3,2	1,3	100		202
M1,7	3,5	1,4	100		178
M2	4	1,6	1000	69	24
M2,3	4,5	1,8	100		95
M2,5	5	2	1000	29	24
M2,6	5	2	100		39

Order ex./Best. ex.: DIN 934 Class/Klasse 6 M1 Zincpl/verz
Article ex./Artikelnr ex.: 93400101

DIN 934

Steel/Stahl
Class/Klasse 8 HDG/feuerverz

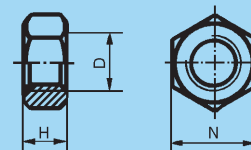

D	N	H	Price/Preis €/1000 pcs/St					
			Boxp./Kartonverp.		Bulk/Grosskartonverp.		Normalp./Standardverp.	
			Box quantity/Verp.	Price/Preis	Box quantity/Verp.	Price/Preis	Box quantity/Verp.	Price/Preis
M6	10	5					500	43
M8	13	6,5	200	64	5000	57	500	59
M10	17	8	100	120	2500	110	200	112
M12	19	10	100	159	1700	140	200	145
M14	22	11					200	590
M16	24	13	50	320	800	285	100	298
M18	27	15					100	530
M20	30	16	25	620	430	570	50	590
M22	32	18					50	1200
M24	36	19	25	1380	300	1250	50	1290
M27	41	22					25	2400
M30	46	24					25	3386
M33	50	26					10	3867
M36	55	29					10	4900
M39	60	31					Bulk/Grossverp.	7700
M42	65	34					Bulk/Grossverp.	13500
M45	70	36					Bulk/Grossverp.	15000
M48	75	38					Bulk/Grossverp.	17200
M56	85	45					Bulk/Grossverp.	38000

Order ex./Best. ex.: DIN 934 Class/Klasse 8 M6 HDG/feuerverz
Article ex./Artikelnr ex.: 9340062

DIN 934

Steel/Stahl Class/Klasse 8
 Yellow ZPL/gelbverz Blackoxide/schwarzoxid
 Dacromet

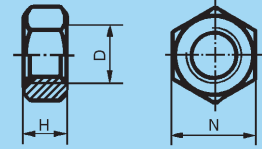

D	N	H	Box quantity/ Verpackung	Price/Preis €/1000 pcs/St			
				Yellow ZPL/ gelbverz	Blackoxide/ schwarzoxid	Blackoxide/ schwarzoxid	Dacromet
M3	5,5	2,4	1000	12		29	
M3,5	6	2,8	1000	15			
M4	7	3,2	1000	14	16	19	
M5	8	4	500	16	19	29	
M6	10	5	500	23	27	35	46
M8	13	6,5	500	38	43	49	59
M10	17	8	200	92	150	128	156
M12	19	10	200	142	240	198	240
M14	22	11	200	233			1900
M16	24	13	100	260			590
M18	27	15	100	490			1900
M20	30	16	50	510			1260
M24	36	19	50	1083			1800
M27	41	22	25	2540			3900
M30	46	24	25	2900			4800
M33	50	26	10	4100			6900
M36							9800

Order ex./Best. ex.: DIN 934 Class/Klasse 8 M3 Yellow ZPL/gelbverz
 Article ex./Artikelnr ex.: 93400303

DIN 934

Left threaded/Linksgewinde
 Steel/Stahl Class/Klasse 8
 Plain/unbeh Zinopl/verz

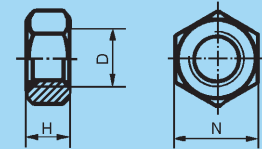

D	N	H	Box quantity/ Verpackung	Price/Preis €/1000 pcs/St	
				Plain/unbeh	Zinopl/verz
M3	5,5	2,4	100		251
M4	7	3,2	100	131	167
M5	8	4	100	165	179
M6	10	5	100	224	237
M8	13	6,5	100	350	372
M10	17	8	100	549	585
M12	19	10	100	729	765
M14	22	11	50	1188	1238
M16	24	13	50	1476	1553
M18	27	15	50	2052	2228
M20	30	16	50	2556	2700
M22	32	18	25	5900	6800
M24	36	19	25	4410	4950
M27	41	22	10	7920	8775
M30	46	24	10	10080	10800
M33	50	26	Bulk/Grossverp.	14220	
M36	55	29	Bulk/Grossverp.	29000	38000

Order ex./Best. ex.: DIN 934 Left threaded/Linksgewinde Class/Klasse 8 M4 Plain/unbeh
 Article ex./Artikelnr ex.: 934L04

DIN 934

Fine thread/Feingewinde
Steel/Stahl Class/Klasse 6
Plain/unbeh Zincpl/verz

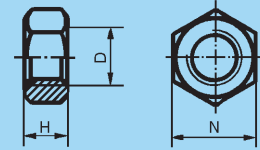

D	N	H	Box quantity/ Verpackung	Price/Preis €/1000 pcs/St	
				Plain/unbeh	Zincpl/verz
M3 x 0,35	5,5	2,4	1000	350	230
M4 x 0,5	7	3,2	1000		240
M5 x 0,5	8	4	1000		350
M6 x 0,5	10	5	500		360
M6 x 0,75	10	5	500		360
Order ex./Best. ex.: DIN 934 Fine pitch/Feingewinde Class/Klasse 6 M3 x 0,35 Zincpl/verz Article ex./Artikelnr ex.: 934030351					

DIN 934

Fine pitch/Feingewinde
Steel/Stahl Class/Klasse 8
Plain/unbeh Zincpl/verz

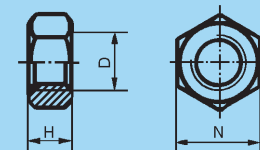

D	N	H	Box quantity/ Verpackung	Price/Preis €/1000 pcs/St	
				Plain/unbeh	Zincpl/verz
M8 x 1	13	6,5	100	491	540
M10 x 1	17	8	100	777	833
M10 x 1,25	17	8	100	777	833
M12 x 1	19	10	100	1025	1080
M12 x 1,25	19	10	100	1025	1080
M12 x 1,5	19	10	100	1025	1080
M14 x 1,5	22	11	100	1485	1598
M16 x 1,5	24	13	100	1890	2138
M18 x 1,5	27	15	50	2600	2700
M18 x 2	27	15	50	2858	3150
M20 x 1,5	30	16	50	3578	3938
M20 x 2	30	16	50	3578	3938
M22 x 1,5	32	18	25	4793	5288
M22 x 2	32	18	25	4793	5288
M24 x 1,5	36	19	25	6188	6750
M24 x 2	36	19	25	6188	6750
M27 x 2	41	22	10	12500	13200
M30 x 1,5	46	24	10	14175	14850
M30 x 2	46	24	10	14175	14850
M33 x 1,5	50	26	Bulk/Grossverp.	20025	21375
M33 x 2	50	26	Bulk/Grossverp.	20025	21375
M36 x 1,5	55	29	Bulk/Grossverp.	24300	27000
M36 x 2	55	29	Bulk/Grossverp.	39000	27000
M36 x 3	55	29	Bulk/Grossverp.	24300	27000
Order ex./Best. ex.: DIN 934 Steel/Stahl Class/Klasse 8 M8 x 1 Plain/unbeh Article ex./Artikelnr ex.: 93408100					

ISO 4032

Steel/Stahl Class/Klasse 8
 Plain/unbeh Zincpl/verz HDG/feuerverz
 Zinc-iron black waxed/zinc-Eisen schwarz bewachst

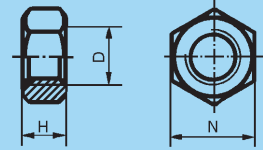

D	N	H	Box quantity/ Verpackung	Price/Preis €/1000 pcs/St			
				Plain/unbeh	Zincpl/verz	HDG/feuerverz	Black waxed/ Zinc-Eisen schwarz bewachst
M3	5,5	2,4	1000	46	12		190
M4	7	3,2	1000	30	14		180
M5	8	4,7	500	39	18		175
M6	10	5,2	500	41	24	69	170
M8	13	6,8	500	49	39	72	168
M10	16	8,4	200	72	75	128	198
M12	18	10,8	200	120	134	165	269
M14	21	12,8	200	250	255	670	510
M16	24	14,8	100	259	265	372	690
M18	27	15,8	100	670	690	845	
M20	30	18	50	690	710	785	890
M22	34	19,4	50	1450	1495	1650	
M24	36	21,5	50	1490	1550	1765	
M27	41	23,8	25	2800	2900	3250	
M30	46	25,6	25	3100	3195	3600	
M33	50	28,7	10	4500	5600	9800	
M36	55	31	10	5900	7700	10400	

Order ex./Best. ex.: ISO 4032 Class/Klasse 8 M3 Plain/unbeh
 Article ex./Artikelnr ex.: 40320030

ISO 4032

Steel/Stahl Class/Klasse 10
 Plain/unbeh Dacromet

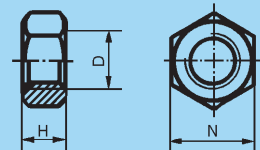

D	N	H	Box quantity/ Verpackung	Price/Preis €/1000 pcs/St	
				Plain/unbeh	Dacromet
M6	10	5,2	500	129	260
M8	13	6,8	500	162	210
M10	16	8,4	200	356	430
M12	18	10,8	200	440	560
M14	21	12,8	200	970	
M16	24	14,8	100	730	910
M20	30	18	50	1100	1530
M24	36	21,5	50	2900	3500
M27	41	23,8	25	4200	
M30	46	25,6	25	5700	

Order ex./Best. ex.: ISO 4032 Class/Klasse 10 M6
 Article ex./Artikelnr ex.: 40321006

DIN 934

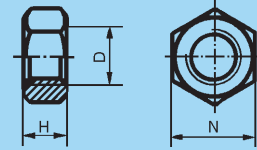

Steel/Stahl Class/Klasse 10/12

D	N	H	Box quantity/ Verpackung	Price/Preis €/1000 pcs/St			
				Class/Klasse 10			Class/Klasse 12
				Plain/unbeh	Zincpl/verz	Dacromet	
M4	7	3,2	200	95			
M5	8	4	200	104			
M6	10	5	200	110	143		
M8	13	6,5	200	120	156		738
M10	17	8	100	289	376	480	1233
M12	19	10	100	390	507		1692
M14	22	11	100	590	790		2600
M16	24	13	50	640	832	970	2700
M18	27	15	50	920			
M20	30	16	50	950	1235		3600
M22	32	18	25	2600			
M24	36	19	25	2700	3510		5500
M27	41	22	25	3269			9400
M30	46	24	25	4600			19475
M33	50	26	10	6500			
M36	55	29	10	11853			26086
M39	60	31	Bulk/Grossverp.	29000			
M42	65	34	Bulk/Grossverp.	32000			
M45	70	36	Bulk/Grossverp.	43650			
M48	75	38	Bulk/Grossverp.	49000			
M56	85	45	Bulk/Grossverp.	59000			

Order ex./Best. ex.: DIN 934 Class/Klasse 10 M4 Plain/unbeh
Article ex./Artikelnr ex.: 9341004

DIN 934

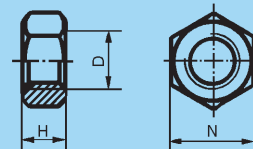

Steel/Stahl Class/Klasse 10
Fine pitch/Feingewinde

D	N	H	Box quantity/ Verpackung	Price/Preis €/1000 pcs/St	
				Plain/unbeh	Dacromet
M12 x 1,25	19	10	100	690	
M12 x 1,5	19	10	100	690	
M14 x 1,5	22	11	100	950	
M16 x 1,5	24	13	100	1100	1800
M18 x 1,5	27	15	50	1400	
M20 x 1,5	30	16	50	1590	
M22 x 1,5	32	18	25	3400	
M24 x 2	36	19	25	3900	
M27 x 2	41	22	25	7600	
M30 x 2	46	24	10	9900	

Order ex./Best. ex.: DIN 934 Steel/Stahl Class/Klasse 10 M12 x 1,25
Article ex./Artikelnr ex.: 9341012125

Hex nut/6-Kantmutter ML6M

SS 2176
Steel/Stahl
Plain/unbeh Zincpl/verz

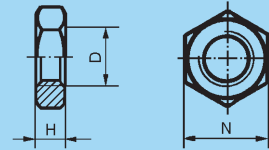

D	N	H	Box quantity/ Verpackung	Price/Preis €/1000 pcs/St	
				Plain/unbeh	Zincpl/verz
M4	7	2,5	1000	81 120	20
M5	8	3	1000		26
M6	10	4	1000		34
M8	13	5	500		59
M10	17	6	500		129
M12	19	8	100		199
M14	22	9	50		990
M16	24	10	50		290
M20	30	12	50		990
M24	36	15			
M30	46	18			

Order ex./Best. ex.: Hex nut/6-Kantmutter Steel/Stahl M4 x 7 x 2,5 Zincpl/verz
Article ex./Artikelnr ex.: ML6M041

DIN 439 B

Steel/Stahl Class/Klasse 04
Plain/unbeh Zincpl/verz

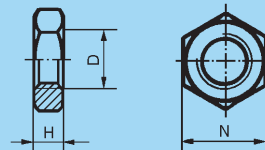

D	N	H	Box quantity/ Verpackung	Price/Preis €/1000 pcs/St	
				Plain/unbeh	Zincpl/verz
M2	4	1,2	500	53	54
M2,5	5	1,6	500	50	51
M3	5,5	1,8	500	27	35
M4	7	2,2	500	29	35
M5	8	2,7	500	41	36
M6	10	3,2	500	56	41
M8	13	4	500	108	51
M10	17	5	500	171	90
M12	19	6	200	279	153
M14	22	7	200		729
M16	24	8	100	518	293
M18	27	9	100		1053
M20	30	10	50	790	638
M22	32	11	50	1560	2484
M24	36	12	50	2100	2808
M27	41	13,5	25		4671
M30	46	15	25	5325	5697
M33	50	16,5	Bulk/Grossverp.		9990
M36	55	18	Bulk/Grossverp.		11259
M39	60	19,5	Bulk/Grossverp.	11597	
M42	65	21	Bulk/Grossverp.	15296	

Order ex./Best. ex.: DIN 439 B Steel/Stahl M2 Plain/unbeh
Article ex./Artikelnr ex.: 43902

DIN 936

Steel/Stahl Class/Klasse 04/17 H
Plain/unbeh Zincpl/verz

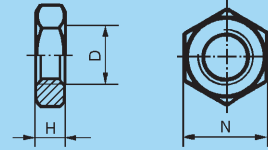

D	N	H	Box quantity/ Verpackung	Price/Preis €/1000 pcs/St	
				Plain/unbeh	Zincpl/verz
M12	19	7	500	435	518
M14	22	8	200	900	1025
M20	30	9	50	2205	2453
M22	32	10	50	3195	3488
M24	36	10	50	3780	4163
M27	41	12	25		6525
M30	46	12	25	7088	8505
M33	50	14	10		14580
M36	55	14	10	15000	15660
M39	60	16	Bulk/Grossverp.		21330
M42	65	16	Bulk/Grossverp.		27270
M45	70	18	Bulk/Grossverp.		32400
M48	75	18	Bulk/Grossverp.		41850
M52	80	20	Bulk/Grossverp.		48600

Order ex./Best. ex.: DIN 936 Steel/Stahl M12 Plain/unbeh
Article ex./Artikelnr ex.: 93612

Hex nut/6-Kantmutter

Large key width/grosse Schlüsselweite
Steel/Stahl Zincpl/verz

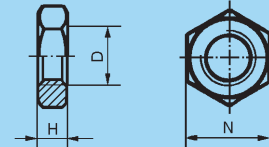

D	N	H	Box quantity/ Verpackung	Price/Preis €/1000 pcs/St
M3	6	2	1000	50
M4	8	2,5	1000	59
M5	9	3	1000	125

Order ex./Best. ex.: Hex nut/6-Kantmutter Large key width/grosse Schlüsselweite Steel/Stahl M3 x 6 x 2 Zincpl/verz
Article ex./Artikelnr ex.: 6KTM3061



DIN 439 B

Fine pitch/Feingewinde
Steel/Stahl Class/Klasse 04
Plain/unbeh Zincpl/verz

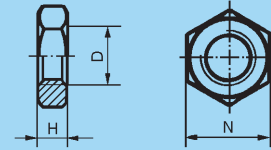

D	N	H	Box quantity/Verp.	Price/Preis €/1000 pcs/St	
				Plain/unbeh	Zincpl/verz
M8 x 1	13	4	100		336
M10 x 1	17	5	100	560	606
M10 x 1,25	17	5	100		626
M12 x 1	19	6	100	810	858
M12 x 1,25	19	6	100		858
M12 x 1,5	19	6	100		1080
M14 x 1,5	22	7	100		1328
M16 x 1,5	24	8	100		1407
M18 x 1,5	27	9	50	2300	2385
M20 x 1,5	30	10	50	3100	3173
M22 x 1,5	32	11	25		4793
M24 x 2	36	12	25		6660
M27 x 2	41	13,5	25		7400
M30 x 2	46	15	25		8600

Order ex./Best. ex.: DIN 439 B Steel/Stahl M8 x 1 Zincpl/unbeh
Article ex./Artikelnr ex.: 439081001

DIN 936

Fine pitch/Feingewinde
Steel/Stahl Class/Klasse 04/17 H
Plain/unbeh Zincpl/verz

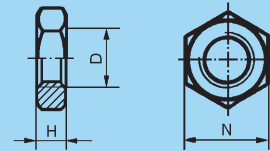

D	N	H	Box quantity/Verp.	Price/Preis €/1000 pcs/St	
				Plain/unbeh	Zincpl/verz
M10 x 1	17	6	500		650
M10 x 1,25	17	6	500		650
M12 x 1,25	19	7	500	878	1054
M12 x 1,5	19	7	500	878	1054
M14 x 1,5	22	8	200	1170	1404
M20 x 1,5	30	9	50	2498	2998
M20 x 2	30	9	50	2498	2998
M22 x 1,5	32	10	50	2970	3564
M22 x 2	32	10	50	2970	3564
M24 x 1,5	36	10	50	4050	4860
M24 x 2	36	10	50	4050	4860
M27 x 1,5	41	12	25	6863	8236
M27 x 2	41	12	25	6863	8236
M30 x 1,5	46	12	25	9000	10800
M30 x 2	46	12	25	9000	10800
M33 x 1,5	50	14	10	12375	14850
M33 x 2	50	14	10	12375	14850
M36 x 1,5	55	14	10	13500	16200
M36 x 2	55	14	10	13500	16200
M36 x 3	55	14	10	13500	16200
M39 x 1,5	60	16	Bulk/Grossverp.	21375	25650
M39 x 3	60	16	Bulk/Grossverp.	21375	25650

Order ex./Best. ex.: DIN 936 Steel/Stahl M10 x 1 Zincpl/verz
Article ex./Artikelnr ex.: 936101001

DIN 936

Left threaded/Linksgewinde
Steel/Stahl Class/Klasse 04/17 H
Plain/unbeh Zinopl/verz

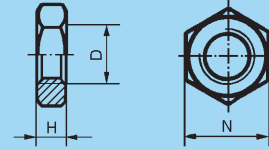

D	N	H	Box quantity/ Verpackung	Price/Preis €/1000 pcs/St	
				Plain/unbeh	Zinopl/verz
M8	13	5	100	431	518
M10	17	6	100	653	765
M12	19	7	100	878	990
M14	22	8	100	1170	1283
M16	24	8	50	1620	1778
M18	27	9	50	2093	2228
M20	30	9	50	2498	2700
M22	32	10	25	3330	3600
M24	36	10	25	4050	4500
M27	41	12	25	6863	7425
M30	46	12	10	10125	11025

Order ex./Best. ex.: DIN 936 Steel/Stahl M8 Plain/unbeh Left threaded/Linksgewinde
Article ex./Artikelnr ex.: 936L08

ISO 4035

Steel/Stahl Class/Klasse 14H/04
Plain/unbeh Zinopl/verz

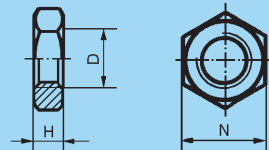

D	N	H	Box quantity/ Verpackung	Price/Preis €/1000 pcs/St	
				Plain/unbeh	Zinopl/verz
M3	5,5	1,8	1000	180	185
M4	7	2,2	1000	190	195
M5	8	2,7	1000	210	220
M6	10	3,2	500	230	240
M8	13	4,0	500	290	330
M10	16	5,0	200	425	470
M12	18	6,0	200	475	580
M14	21	7,0	200		1070
M16	24	8,0	100	1100	1390
M20	30	10,0	100	2200	2900
M24	36	12,0	50	4500	5300
M30	46	15,0	25	5900	7200
M36	55	18,0	10	6850	8400

Order ex./Best. ex.: ISO 4035 Steel/Stahl M3 Plain/unbeh
Article ex./Artikelnr ex.: 40350030

DIN 929

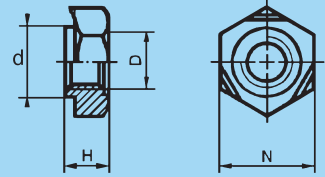

Steel/Stahl Plain/unbeh

D	N	H	d	Box quantity/Verp.	Price/Preis €/1000 pcs/St
M3	7,5	3	4,5	500	34
M4	9	3,5	6	500	40
M5	10	4	7	500	45
M6	11	5	8	500	52
M8	14	6,5	10,5	500	59
M10	17	8	12,5	200	99
M12	19	10	14,8	200	165
M14	22	11	16,8	100	585
M16	24	13	18,8	100	446

Order ex./Best. ex.: DIN 929 Steel/Stahl M3
Article ex./Artikelnr ex.: 92903

DIN 928

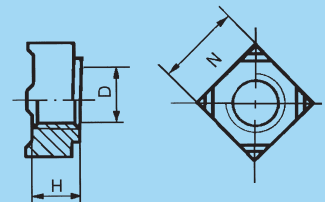

Metric/UNC- UNF-thread/Gewinde
Steel/Stahl Plain/unbeh

D	N	H	Box quantity/Verp.	Price/Preis €/1000 pcs/St
M4	7	3,5	500	46
M5	9	4,2	500	49
M6	10	5	500	54
M8	14	6,5	500	65
M10	17	8	200	136
M12	19	9,5	200	235
M14	22	11	100	970
5/16 UNC	14	6,5	500	390
7/16 UNF	19	9	200	795

Order ex./Best. ex.: DIN 928 M4
Article ex./Artikelnr ex.: 92804

FN Square weldnut/ 4-kant Schweissmutter

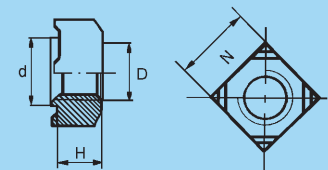

With collar/mit Führung
Steel/Stahl Plain/unbeh

D	N	H	d	Box quantity/Verp.	Price/Preis €/1000 pcs/St
M4	8	3,5	6	500	216
M5	9	4,2	7	500	176
M6	10	5	8	500	197
M8	14	6,5	11,2	500	351
M10	17	8	14	200	563
M12	19	9,5	16	200	680

Order ex./Best. ex.: Square weldnut with collar/4-kant Schweissmutter mit Führung M4
Article ex./Artikelnr ex.: FN04

FK4M Square weldnut/ 4-kant Schweissmutter

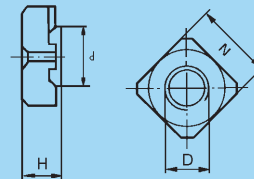

Volvo drawing/Zeichnung 1053291
Steel/Stahl Plain/unbeh

D	N	H	d	Box quantity/Verp.	Price/Preis €/1000 pcs/St
M6	12,7	5,6	9,53	1000	285
M8	14,28	6,4	11,91	1000	360
M10	15,88	7,9	14,28	500	555
M12	20,64	11,1	17,37	200	912

Order ex./Best. ex.: Square weldnut/4-kant Schweissmutter Steel/Stahl M6 Plain/unbeh
Article ex./Artikelnr ex.: FK4M06

Spot weld nut/ Anschweissmutter

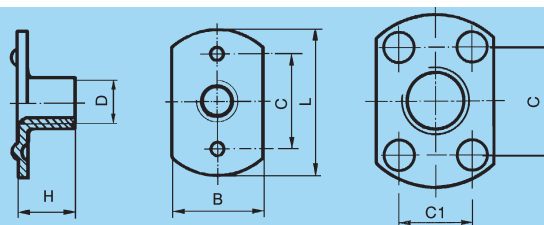

Steel/Stahl Plain/unbeh

Thread/Gewinde	Performance/ Ausführung*	(L)	(B)	(C)	(C1)	Material thickness/ Materialdicke	(H)	(D)	Box quantity/ Verpackung	Price/Preis €/1000 pcs/St
M4	A	17	9,0	12		0,9	6,0	5,2	500	325
M4	B	17	9,0	12		0,9	6,0	5,2	500	325
M4	C	17	9,0			0,9	6,0	5,2	500	325
M5	A	19	11,0	14		1,3	7,5	6,1	500	410
M5	B	19	11,0	14		1,3	7,5	6,1	500	410
M5	C	19	11,0			1,3	7,5	6,1	500	410
M6	A	22	14,0	16		1,5	8,5	7,9	500	560
M6	B	22	14,0	16		1,5	8,5	7,9	500	560
M6	C	22	14,0			1,5	8,5	7,9	500	560
M8	A	26	18,0	17	10	2,0	11,0	10,4	200	800
M8	B	26	18,0	17	10	2,0	11,0	10,4	200	800
M8	C	26	18,0			2,0	11,0	10,4	200	800
M10	A	26	18,0	17	10	2,0	10,5	11,6	200	860
M10	B	26	18,0	17	10	2,0	10,5	11,6	200	860
M10	C	26	18,0			2,0	10,5	11,6	200	860
M12	A	29	20,5	17	13	2,2	12,5	13,7	100	1200
M12	C	29	20,5			2,2	12,5	13,7	100	1200

Order ex./Best. ex.: Spot weld nut/Anschweissmutter Steel/Stahl M4 A
Article ex./Artikelnr ex.: SMRP04A

Performance/Ausführung:



DIN 315

GT Malleable cast iron/Temperguß
Plain/unbeh Zincpl/verz

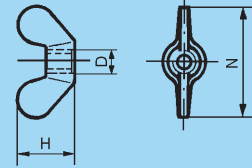

D	N	H	Box quantity/ Verpackung	Price/Preis €/1000 pcs/St	
				plain/unbeh	zincpl/verz
M4	19	10	100	417	323
M5	25	12	100	531	330
M6	32	16	100	657	390
M7	32	16	100	850	900
M8	38	19	100	918	495
M10	50	24	100	1458	1090
M12	64	32	50	2466	2300
M14	68	34	50	3672	4388
M16	72	36	25	4770	3990
M20	89	45	25	11880	13275
M24	109	56	10	21420	24300

Order ex./Best. ex.: DIN 315 M4 Plain/unbeh
Article ex./Artikelnr ex.: 31504

Wingnut American type/ Flügelmutter amerikanische Typ

ANSI B18.17 A Light (~DIN 314)
Steel/Stahl
Zincpl/verz

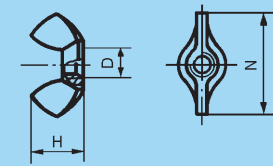

D	N	H	Box quantity/ Verpackung	Price/Preis €/1000 pcs/St
M3	17,6	8,6	1000	257
M4	17,6	8,6	1000	260
M5	22,5	11	1000	267
M6	27,8	13,6	500	290
M8	30,3	14,8	500	325
M10	36,2	17,7	200	839
M12	49,4	24,1	100	1932

We can also deliver acc to DIN 314./
Wir können auch DIN 314 liefern.

Order ex./Best. ex.: Wingnut American type/Flügelmutter Amerikanische Typ Steel/Stahl M3 Zincpl/verz
Article ex./Artikelnr ex.: 314AM031

Wingnut Japanese type/ Flügelmutter japanischer Typ (~DIN 314)

M-thread/-Gewinde UNC- UNF-thread/-Gewinde
Steel/Stahl Zinopl/verz

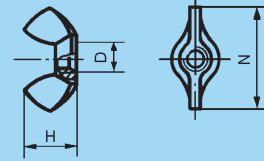

D	N	H	Box quantity/ Verpackung	Price/Preis €/1000 pcs/St
M3	18	9	500	134
M4	22	12	500	171
M5	22	12	500	180
M6	27	14	200	229
M8	32	17	200	344
M10	37	19	100	540
M12	49	25	100	1359
No 10 UNC	22	12	500	180
1/4 UNC	27	14	200	229
5/16 UNC	32,5	17,5	200	344
3/8 UNC	37,5	19,5	100	540

We can also deliver acc to DIN 314./
Wir können auch DIN 314 liefern.

Order ex./Best. ex.: Wingnut Japanese type/Flügelmutter japanisch Typ Steel/Stahl M3 Zinopl/verz
Article ex./Artikelnr ex.: 314JPN031

Wingnut "DIN 315"/ Flügelmutter "DIN 315"

UNC-thread/UNC-Gewinde
Zinopl/verz

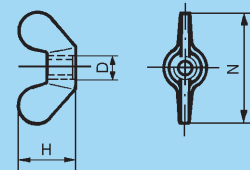

D	N	H	Box quantity/ Verpackung	Price/Preis €/1000 pcs/St
1/4 UNC	32	16	200	1700
5/16 UNC	40	20	200	1900
3/8 UNC	50	25	100	2800
1/2 UNC	64	32	100	4600
5/8 UNC	72	36	50	6800
3/4 UNC	90	45	50	9675

Order ex./Best. ex.: DIN 315 1/4 UNC Zinopl/verz
Article ex./Artikelnr ex.: 315U141

Hex full nut/Sechskantmutter UNC UNC- UNF-thread/gewinde

Ansi B 18.2.2 Steel/Stahl
Plain/unbeh Zinopl/verz HDG/feuerverz

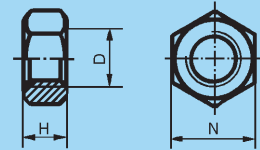

D	N (mm)	N (tum)	H	Price/Preis €/1000 pcs/St				
				UNC- Plain/unbeh	UNC- Zinopl/verz	UNC- HDG/feuerverz	UNF- Plain/unbeh	UNF- Zinopl/verz
No 10	9,5	3/8	3,3	220	132		180	210
1/4	11,1	7/16	5,6	90	41	96	69	50
5/16	12,7	1/2	6,7	97	53	240	128	79
3/8	14,3	9/16	8,3	128	73	430	139	87
7/16	17,5		9,5	469	134	850	470	230
1/2	19	3/4	11,1	184	150	490	390	295
9/16	22,2	7/8	12,3	608	650		608	650
5/8	23,8	15/16	13,9	429	390	880	440	390
3/4	28,6	1 1/8	16,3	530	540	950	590	720
7/8	33,3	1 5/16	19,1	1100	1460	3813	2400	2900
1"	38,1	1 1/2	21,8	1490	1900	3962	2650	3300
1 1/8	42,9	1 1/2	24,6	4500	5700	9200		
1 1/4	47,6	1 7/8	27	4700	6100	9556	7200	9600
1 3/8	52,4	2 1/16	29,8	7700	9500			
1 1/2	57,2	2 1/4	32,5	7900	9900	14000	12600	16400
1 3/4	66,7	2 5/8	38,1	14000	19000	37500		
2"	76,2	3	43,7	16000	23900	49000		
2 1/4	85,7	3 3/8	48,8	99000	120000			
2 1/2	95,2	3 3/4	54,4	105000	130000			
2 3/4	104,8	4 1/8	59,9	109000	134000			
3"	114,3	4 1/2	65,5	190000	146000			

Order ex./Best. ex.: Hex full nut/Sechskantmutter Steel/Stahl No 10 UNC Zinopl/verz
Article ex./Artikelnr ex.: 934U101

Box quantity/Verpackung

No10-5/16	3/8-1/2	9/16-5/8	3/4-1"	1 1/8-1 1/2	1 3/4-3"
500	200	100	50	10	Loose/

Hex full nut/Sechskantmutter UNC left threaded/Linksgewinde

Ansi B 18.2.2 Steel/Stahl
Plain/unbeh Zinopl/verz

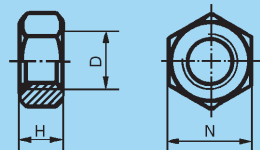

D	N (mm)	N (tum)	H	Box quantity/ Verpackung	Price/Preis €/1000 pcs/St	
					Plain/unbeh	Zinopl/verz
1/4	11,1	7/16	5,6	200	950	
5/16	12,7	1/2	6,7	200		1460
3/8	14,3	9/16	8,3	100	2900	
1/2	19	3/4	11,1	50	3500	
5/8	23,8	15/16	13,9	25	4941	6211
3/4	28,6	1 1/8	16,3	25	6850	
7/8	33,3	1 5/16	19,1	10	7900	
1"	38,1	1 1/2	21,8	10	13425	18179

Order ex./Best. ex.: Hex full nut/Sechskantmutter Steel/Stahl UNC Left threaded/Linksgewinde Plain/unbeh
Article ex./Artikelnr ex.: 934UL14

DIN 1587

Steel/Stahl
Plain/unbeh Zincpl/verz

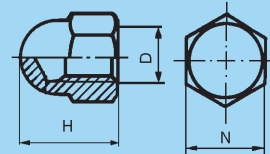

D	N	H	Box quantity/ Verpackung	Price/Preis €/1000 pcs/St		
				Plain/unbeh	Zincpl/verz	Turned parts/gedreht Zincpl/verz
M3	5,5	6	500	149	155	
M4	7	8	500	149	155	
M5	8	10	500	323	275	413
M6	10	12	200	338	280	420
M8	13	15	200	420	360	540
M10	17 (16)*	18	200	590	560	840
M12	19 (18)*	22	100	1433	1250	1875
M14	22 (21)*	25	100	2400	2250	
M16	24	28	100	2138	1850	2775
M18	27	32	25	4800	4900	
M20	30	34	25	3300	3600	
M22	32 (34)*	39	10	7050	7200	
M24	36	42	10	7050	7200	

Order ex./Best. ex.: DIN 1587 Steel/Stahl M3 Plain/unbeh *Key width acc. to ISO (= DIN 1587 edition oct 2000) on request /
Article ex./Artikelnr ex.: 158703 /Schlüsselweite nach ISO = DIN 1587 Okt 2000 nach Anfrage

Hex domenut/Hutmutter

Japanese type/japanische Form
Steel/Stahl Zincpl/verz

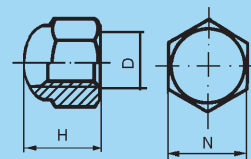

D	N	H	Box quantity/Verpackung	Price/Preis €/1000 pcs/St
M4	7	6,2	500	135
M5	8	7,5	500	155
M6	10	9,5	200	198
M8	13	12,5	200	356

Order ex./Best. ex.: Hex domenut/Hutmutter JPN Steel/Stahl M4 Zincpl/verz
Article ex./Artikelnr ex.: 1587JPN041

Hexagon domed cap nut/ Sechskant-Hutmutter

UNC-thread/UNC-Gewinde
Steel/Stahl Zincpl/verz

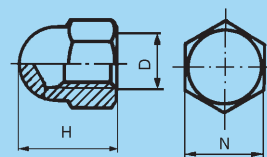

D	N (mm)	N (tum)	H	Box quantity/ Verpackung	Price/Preis €/1000 pcs/St
no 10	9,5	3/8"	10	200	382
3/8	14,3	9/16"	18	200	1400
5/8	23,8	15/16"	30	100	5900

Order ex./Best. ex.: Hexagon domed cap nut/Sechskant-Hutmutter Steel/Stahl no 10 UNC Zincpl/verz
Article ex./Artikelnr ex.: 1587U101

DIN 985

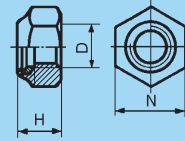

Steel/Stahl
Class/Klasse 6 Zncpl/verz

D	N	H	Boxp./Kartonverp.		Bulk/Grosskartonverp.		Normalp./Standardverp.	
			Box quantity/Verp.	Price/Preis	Box quantity/Verp.	Price/Preis	Box quantity/Verp.	Price/Preis
M2	4,5	2,5					200	990
M2,5	5	3,8					200	257
M2,6	5	3,8					200	960
M3	5,5	4	200	29	60000	25	500	26
M3,5	6	4,5					200	865
M4	7	5	200	30	30000	26	500	27
M5	8	5	200	33	10000	29	500	30
M6	10	6	200	42	10000	35	500	36
M7	11	7,5				220	100	224
M8	13	8	200	51	5000	45	500	46
M10	17	10	100	120	2200	109	200	111
M12	19	12	100	170	1500	156	200	159
M14	22	14	50	260	1000	232	100	240
M16	24	16	50	340	750	310	100	320
M18	27	18,5	25				50	730
M20	30	20	25	770	400	729	50	740
M22	32	22					25	1500
M24	36	24			200	1510	25	1560
M27	41	27					10	4850
M30	46	30					10	4900
M33	50	33					10	11129
M36	55	36					10	12990
M39	60	39					Loose/	37848
M42	65	42					Loose/	39000
M45	70	45					Loose/	65000
M48	75	48					Loose/	94000

Order ex./Best. ex.: DIN 985 Class/Klasse 6 M2 Zncpl/verz
Article ex./Artikelnr ex.: 9850201

DIN 985

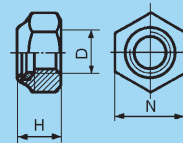

Steel/Stahl
Class/Klasse 8 Zncpl/verz

D	N	H	Box quantity/Verpackung	Price/Preis €/1000 pcs/St
M4	7	5	500	40
M5	8	5	500	41
M6	10	6	500	54
M8	13	8	500	59
M10	17	10	200	156
M12	19	12	200	198
M14	22	14	100	350
M16	24	16	100	420
M18	27	18,5	50	850
M20	30	20	50	990
M22	32	22	25	1900
M24	36	24	25	1990
M27	41	27	10	6900
M30	46	30	10	7200
M36	55	36	10	14300
M39	60	39	10	39800

Order ex./Best. ex.: DIN 985 Class/Klasse 6 M4 Zncpl/verz
Article ex./Artikelnr ex.: 98580401

DIN 982

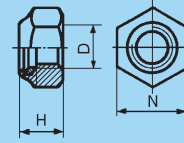

Steel/Stahl
Class/Klasse 8 Zinopl/verz

D	N	H	Box quantity /Verp.		Price/Preis €/1000 pcs/St	
			Normalp./Standardverp.	Bulk/Grosskartonverp.	Normalp./Standardverp.	Bulk/Grosskartonverp.
M4*	7	5	500		59	
M5	8	6,3	500		39	
M6	10	8	500	8000	44	43
M8	13	9,5	500	4000	64	63
M10	17	11,5	200	2000	130	128
M12	19	14	200	1200	179	176
M14	22	16	100	900	395	385
M16	24	18	100	600	430	420
M18	27	20	100		890	
M20	30	22	100		895	875
M22	32	25	25		2900	
M24	36	28	25		2990	
M30*	46	33	10		9900	
M36*	55	36	10		14900	

Order ex./Best. ex.: Din 982 Class/Klasse 8 M4 Zinopl/verz
Article ex./Artikelnr ex.: 982041

* Not incl. in DIN 982/Nicht in DIN 982

DIN 6924

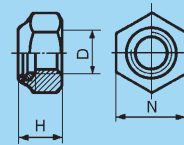

(ISO 7040) Steel/Stahl
Class/Klasse 8 Zinopl/verz

D	N	H	Box quantity/ Verpackung	Price/Preis €/1000 pcs/St
M4	7	6	500	49
M5	8	6,8	500	55
M6	10	8	500	62
M8	13	9,5	500	85
M10	16	11,9	200	139
M12	18	14,9	200	198
M14	21	17	100	590
M16	24	19,1	100	595
M20	30	22,8	50	1210
M24	36	27,1	25	3700

Order ex./Best. ex.: Din 6924 Class/Klasse 8 M4 Zinopl/verz
Article ex./Artikelnr ex.: 6924041

DIN 985

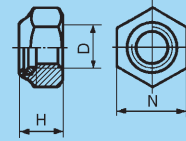

Fine pitch/Feingewinde
Steel/Stahl Class/Klasse 6 Zincpl/verz

D	N	H	Box quantity/Verpackung	Price/Preis €/1000 pcs/St
M8 x 1	13	8	200	585
M10 x 1	17	10	200	935
M10 x 1,25	17	10	200	935
M12 x 1	19	12	200	1305
M12 x 1,25	19	12	200	1305
M12 x 1,5	19	12	200	1305
M14 x 1,5	22	14	100	2273
M16 x 1,5	24	16	100	2813
M18 x 1,5	27	18,5	50	3218
M18 x 2	27	18,5	50	3218
M20x 1,5	30	20	50	4230
M20 x 2	30	20	50	4230
M22 x 1,5	32	22	25	6300
M22 x 2	32	22	25	6300
M24 x 1,5	36	24	25	7313
M24 x 2	36	24	25	7313
M27 x 2	41	27	25	13500
M30 x 2	46	30	10	16875
M33 x 2	50	33	10	26325
M36 x 3	55	36	10	33975
M39 x 3	60	39	Bulk/Grossverp.	45000
M42 x 3	65	42	Bulk/Grossverp.	83250
M45 x 3	70	45	Bulk/Grossverp.	84975
M48 x 3	75	48	Bulk/Grossverp.	100125

Order ex./Best. ex.: DIN 985 Steel/Stahl M8 x 1 Zincpl/verz
Article ex./Artikelnr ex.: 985081001

DIN 985

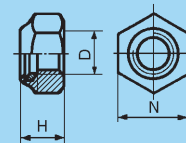

Fine pitch/Feingewinde
Steel/Stahl Class/Klasse 10 Zincpl/verz

D	N	H	Box quantity/ Verpackung	Price/Preis €/1000 pcs/St Zincpl/verz
M8 x 1	13	8	200	878
M10 x 1	17	10	200	1403
M12 x 1,25	19	12	200	1958
M12 x 1,5	19	12	200	1958
M14 x 1,5	22	14	100	3410
M16 x 1,5	24	16	100	4220
M18 x 1,5	27	18,5	50	4827
M20 x 1,5	30	20	50	6345
M20 x 2	30	20	50	6345
M22 x 1,5	32	22	25	9450
M24 x 1,5	36	24	25	10970
M24 x 2	36	24	25	10970
M30 x 2	46	30	10	25310

Order ex./Best. ex.: DIN 985 Steel/Stahl Class/Klasse 10 M8 x 1 Zincpl/verz
Article ex./Artikelnr ex.: 98510081001

DIN 985

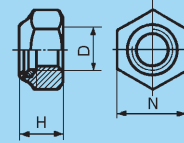

Steel/Stahl
Class/Klasse 10 Zincpl/verz

D	N	H	Box quantity/Verpackung	Price/Preis €/1000 pcs/St
M5	8	5	500	552
M6	10	6	500	585
M8	13	8	500	833
M10	17	10	200	1125
M12	19	12	200	1620
M14	22	14	100	2565
M16	24	16	100	3015
M18	27	18,5	50	3488
M20	30	20	50	5625
M22	32	22	25	7900
M24	36	24	25	8325
M27	41	27	25	9900
M30	46	30	10	16000
M36	55	36	10	19400

Order ex./Best. ex.: DIN 985 Class/Klasse 10 M5 Zincpl/verz
Article ex./Artikelnr ex.: 98510051

DIN 6924

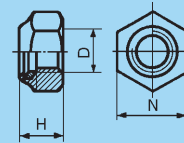

(ISO 7040) Steel/Stahl
Class/Klasse 10 Zincpl/verz

D	N	H	Box quantity/Verpackung	Price/Preis €/1000 pcs/St
M5	8	6,8	500	115
M6	10	8	500	120
M8	13	9,5	500	135
M10	16	11,9	200	285
M12	18	14,9	200	385
M14	21	17	100	958
M16	24	19,1	100	2500
M18	27	20,6	50	2750
M20	30	22,8	50	2850
M22	34	24,5	25	3250
M24	36	27,1	25	3900

Order ex./Best. ex.: DIN 6924 Class/Klasse 10 M5 Zincpl/verz
Article ex./Artikelnr ex.: 692410051

DIN 980-V

Steel/Stahl
Class/Klasse 8 Zncpl/verz

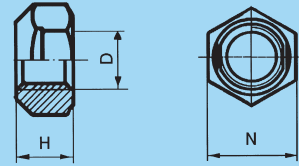

D	N	H	Box quantity/Verpackung	Price/Preis €/1000 pcs/St
M4	7	4,2	500	99
M5	8	5,1	500	95
M6	10	6	500	41
M8	13	8	500	69
M10	17	10	200	158
M12	19	12	200	230
M14	22	14	100	390
M16	24	16	100	544
M18	27	18	50	2950
M20	30	20	50	3200
M24	36	24	25	4500
M27	41	27	25	5834
M30	46	30	25	9594

Order ex./Best. ex.: DIN 980 Class/Klasse 8 M4 Zncpl/verz
Article ex./Artikelnr ex.: 980041

DIN 980-V

Fine pitch/Feingewinde
Steel/Stahl Class/Klasse 8 Zncpl/verz

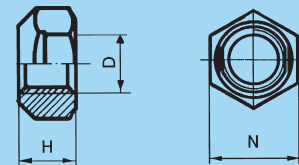

D	N	H	Box quantity/Verpackung	Price/Preis €/1000 pcs/St
M8 x 1	13	8	500	339
M10 x 1,25	17	10	200	735
M12 x 1,25	19	12	200	927
M12 x 1,5	19	12	200	927
M14 x 1,5	22	14	100	1356
M16 x 1,5	24	16	100	1698
M18 x 1,5	27	18	50	3500
M20 x 1,5	30	20	50	3900
M22 x 1,5	32	22	25	6500
M24 x 2	36	24	25	6900
M30 x 2	46	30	25	11200
M36 x 3	55	36	10	16000

Order ex./Best. ex.: DIN 980 Fine pitch/Feingewinde Class/Klasse 8 M8 x 1 Zncpl/verz
Article ex./Artikelnr ex.: 9808081001

DIN 6925

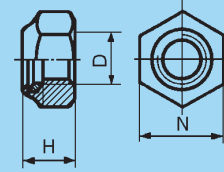

(~ISO 7042) Steel/Stahl
Class/Klasse 8 Zinopl/verz

D	N	H	Box quantity/Verpackung	Price/Preis €/1000 pcs/St
M5	8	5,1	500	65
M6	10	6	500	69
M8	13	8	500	133
M10	16	10	200	210
M12	18	12	200	349
M14	21	14	50	1400
M16	24	16	100	670
M18	27	18	50	3200
M20	30	20	50	1900
M24	36	24	25	3100
M27	41	27	25	12400
M30	46	30	25	16800

Order ex./Best. ex.: DIN 6925 Steel/Stahl Class/Klasse 8 M5 Zinopl/verz
Article ex./Artikelnr ex.: 6925051

DIN 6926

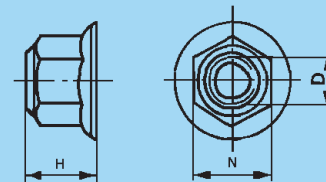

(ISO 7043) Steel/Stahl
Class/Klasse 8 Zinopl/verz

D	N	H	Box quantity/Verpackung	Price/Preis €/1000 pcs/St
M5	8	7,1	200	115
M6	10	9,1	200	116
M8	13	11,1	200	162
M10	15	13,5	100	281
M12	18	16,1	100	466
M16	24	20,3	50	995
M20	30	24,8	25	2700

Order ex./Best. ex.: DIN 6926 Steel/Stahl Class/Klasse 8 M5 Zinopl/verz
Article ex./Artikelnr ex.: 6926051

DIN 6927

(ISO 7044) Steel/Stahl
Class/Klasse 8 Zincl/verz

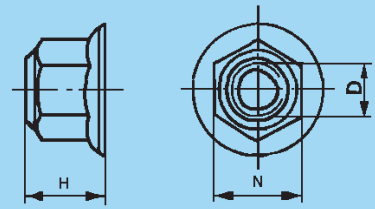

D	N	H	Box quantity/Verpackung	Price/Preis €/1000 pcs/St
M5	8	6,2	500	170
M6	10	7,3	200	175
M8	13	9,4	200	196
M10	15	11,4	100	290
M12	18	13,8	100	529
M16	24	18,3	50	2200

Order ex./Best. ex.: DIN 6927 Steel/Stahl Class/Klasse 8 M6 Zincl/verz
Article ex./Artikelnr ex.: 6927051

DIN 980-M

Steel/Stahl
Class/Klasse 8 HDG/feuerverz

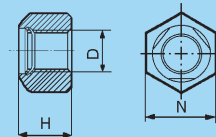

D	N	H	Box quantity/Verpackung	Price/Preis €/1000 pcs/St
M8	13	8	100	3900
M10	17	10	100	3750
M12	19	12	100	4350
M16	24	16	50	7650
M20	30	20	25	22200
M24	36	22	25	31500

Order ex./Best. ex.: DIN 980 Steel/Stahl Class/Klasse 8 M8 HDG/feuerverz
Article ex./Artikelnr ex.: 980M082

DIN 986

Steel/Stahl
Class/Klasse 6 Zinopl/verz

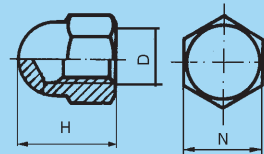

D	N	H	Box quantity/Verpackung	Price/Preis €/1000 pcs/St
M4	7	9,6	500	434
M5	8	10,5	500	492
M6	10	12	500	510
M8	13	14	200	804
M10	17 (16)*	18,1	200	1278
M12	19 (18)*	22,5	100	1800
M16	24	27,5	50	2268
M20	30	35	50	7900

Order ex./Best. ex.: DIN 986 Steel/Stahl M4 Zinopl/verz *Key width acc. to ISO (= Din 986 edition Feb 2000) on request/
Article ex./Artikelnr ex.: 986041 Schlüsselweite nach ISO (= Din 986 Feb 2000) nach Anfrage.

Self locking nylon ins./Locking mutter

UNC UNF
IFI 100
Steel/Stahl Zinopl/verz

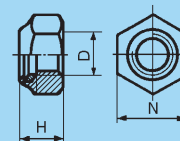

D	N (mm)	N (tum)	H	Box quantity/ Verpackung	Price/Preis €/1000 pcs/St	
					UNC	UNF
No10	9,5	3/8	6,1	200	560	
1/4	11,1	7/16	8,3	200	65	129
5/16	12,7	1/2	9,1	200	94	148
3/8	14,3	9/16	11,9	200	138	230
7/16	17,5	11/16	13,3	200		582
1/2	19	3/4	15,5	100	259	590
9/16	22,2	7/8	16,7	50	990	
5/8	23,8	15/16	19,4	50	750	750
3/4	28,6	1 1/8	22,6	50	1766	2400
7/8	33,3	1 5/16	25,4	25	6500	6500
1"	38,1	1 1/2	28,6	25	7471	7471
1 1/4	47,6	1 7/8	36,9	10	22560	22560
1 1/2	57,2	2 1/4	42,4	10		54335

Order ex./Best. ex.: Self locking nylon ins./Locking mutter Steel/Stahl IFI 100 No 10 UNC Zinopl/verz
Article ex./Artikelnr ex.: 982U101

DIN 6923

(ISO 4161) Class/Klasse 8
Steel/Stahl Zincpl/verz

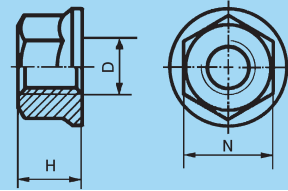

D	N	H	Box quantity/Verpackung	Price/Preis €/1000 pcs/St
M4	7	5	500	90
M5	8	5	500	49
M6	10	6	500	58
M8	13	8	200	78
M10	15	10	200	149
M12	18	12	200	232
M16	24	16	100	695
M20	30	20	50	2759

Order ex./Best. ex.: DIN 6923 Steel/Stahl M4 Zincpl/verz
Article ex./Artikelnr ex.: 69238041

Flangenut with serration/ Flangemutter mit Sperrzähnen

(~DIN 6923 SS-ISO 4161) Class/Klasse 8
Steel/Stahl Zincpl/verz

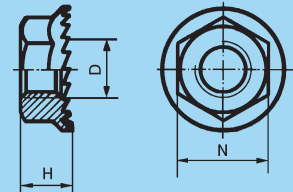

D	N	H	Box quantity/Verpackung	Price/Preis €/1000 pcs/St
M4	7	5	500	90
M5	8	5	500	49
M6	10	6	500	58
M8	13	8	200	78
M10	15	10	200	149
M12	18	12	200	232
M14	21	14	100	990
M16	24	16	100	990

Order ex./Best. ex.: DIN 6923 With serration/mit Sperrzähnen Steel/Stahl M4 Zincpl/verz
Article ex./Artikelnr ex.: 6923Z8041

Flangenut high/Fl.mutter hoch

Class 8/Klasse 8
Steel/Stahl Zincpl/verz

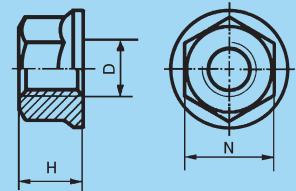

D	N	H	Box quantity/Verpackung	Price/Preis €/1000 pcs/St
M6*	10	8,2	200	560
M16*	24	18,9	50	6600
M20*	30	20	50	17800

*OBS! Outgoing article/
Ablaufende Artikel

Order ex./Best. ex.: Flangenut high/Fl.mutter hoch Class 8/Klasse 8 M6 Zincpl/verz
Article ex./Artikelnr ex.: M6MFH061

Castle nut/Kronenmutter DIN 935-1

Steel/Stahl Class/Klasse 6
Plain/unbeh Zinopl/verz

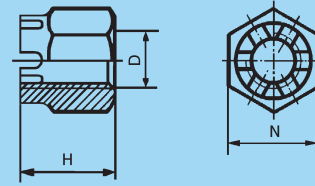

D	N	H	Box quantity/ Verpackung	Price/Preis €/1000 pcs/St	
				Plain/unbeh	Zinopl/verz
M4	7	5	100	790	850
M5	8	6	100	790	850
M6	10	7,5	100	801	870
M8	13	9,5	100	810	880
M10	17 (16)*	12	100	864	1575
M12	19 (18)*	15	100	1350	1875
M14	22 (21)*	16	50	2088	1950
M16	24	19	50	2106	2300
M18	27	21	25	3240	3600
M20	30	22	25	3834	3980
M22	32 (34)*	26	25	4860	5175
M24	36	27	25	6300	6800
M27	41	30	10	9360	9900
M30	46	33	10	11880	12700
M33	50	35	Bulk/Grossverp.	15840	19125
M36	55	38	Bulk/Grossverp.	21060	24900
M39	60	40	Bulk/Grossverp.	26280	28125
M42	65	46	Bulk/Grossverp.	35280	37125
M45	70	48	Bulk/Grossverp.	42840	45000
M48	75	50	Bulk/Grossverp.	72000	74250
M52	80	54	Bulk/Grossverp.	85500	90000
M56	85	57	Bulk/Grossverp.	123750	130500
M60	90	63	Bulk/Grossverp.	144000	153000
M64	95	66	Bulk/Grossverp.	175500	184500
M68	100	69	Bulk/Grossverp.	339750	351000
M72 x 6	105	73	Bulk/Grossverp.	371250	382500
M76 x 6	110	76	Bulk/Grossverp.	436500	447750
M80 x 6	115	79	Bulk/Grossverp.		378750
M90 x 6	130	92	Bulk/Grossverp.		547500
M100 x 6	145	100	Bulk/Grossverp.	730500	757500

Order ex./Best. ex.: DIN 935-1 Steel/Stahl M4 Plain/unbeh* Key width acc. to ISO (= Din 935 edition Oct 2000) on request/
Article ex./Artikelnr ex.: 935004 Schlüsselweite nach ISO (= Din 935 Okt 2000) nach Anfrage.

Castle nut/Kronenmutter DIN 935-1

Fine pitch thread/Feingewinde
Steel/Stahl Class/Klasse 6 Zinopl/verz

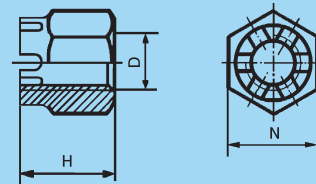

M8 x 1	13	9,5	100	1647
M10 x 1,25	17 (16)*	12	100	2601
M12 x 1,25	19 (18)*	15	100	3726
M14 x 1,5	22 (21)*	16	50	4230
M16 x 1,5	24	19	50	4338
M18 x 1,5	27	21	25	5472
M20 x 1,5	30	22	25	7200
M22 x 1,5	32 (34)*	26	25	9180
M24 x 2	36	27	25	11700
M30 x 2	46	33	10	21185
M36 x 3	55	38	Bulk/Grossverp.	52875

Order ex./Best. ex.: DIN 935-1 Steel/Stahl M8 x 1 Zinopl/verz *Key width acc. to ISO (= Din 935 edition Oct 2000) on request/
Article ex./Artikelnr ex.: 935081001 Schlüsselweite nach ISO (= Din 935 Okt 2000) nach Anfrage.

Square nut/Vierkantmutter DIN 557

Steel/Stahl
Plain/unbeh Zincl/verz

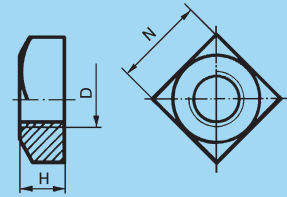

D	N	H	Box quantity/ Verpackung	Price/Preis €/1000 pcs/St	
				Plain/unbeh	Zincl/verz
M5	8	4	500	185	126
M6	10	5	500	212	143
M8	13	6,5	200	309	284
M10*	17 (16)*	8	100	527	563
M12	19 (18)*	10	100	720	912
M16	24	13	50	1418	2168
M20	30	16	50		3510

Order ex./Best. ex.: DIN 557 Steel/Stahl M5 Plain/unbeh
Article ex./Artikelnr ex.: 55705

*Key width acc. to ISO 272 on request/
Schlüsselweite nach ISO 272 nach Anfrage.

Square nut/Vierkantmutter DIN 562

Steel/Stahl
Plain/unbeh Zincl/verz

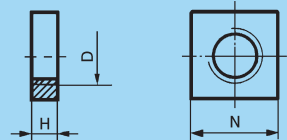

D	N	H	Box quantity/ Verpackung	Price/Preis €/1000 pcs/St	
				Plain/unbeh	Zincl/verz
M2	4	1,2	100	117	59
M2,5	5	1,6	100		57
M3	5,5	1,6	1000	117	44
M3,5	6	2	100		63
M4	7	2	1000	125	45
M5	8	2,5	500	144	66
M6	10	3	500	162	116
M8	13	4	200	261	207
M10	17 (16)*	5	100	408	428

Order ex./Best. ex.: DIN 562 Steel/Stahl M2 Plain/unbeh
Article ex./Artikelnr ex.: 562020

*Key width acc. to DIN 562 edition Feb 2000 on request/
Schlüsselweite nach DIN 562 Feb 2000 nach Anfrage.

Hexnuts/6-Kantmutter

Thin/Niedrige
W-thread/W-Gewinde
Steel/Stahl Zincl/verz

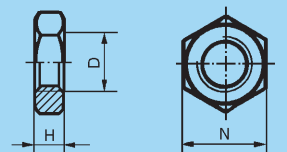

D	N	H	Box quantity/Verpackung	Price/Preis €/1000 pcs/St
3/16	9	3	1000	264
1/4	11	3,5	1000	428

Order ex./Best. ex.: Hex nut/6-Kantmutter Steel/Stahl W3/16 x 9 x 3 Zincl/verz
Article ex./Artikelnr ex.: 439W3161

Hexagon long nut/ Sechskant langmutter M6HM

Steel/Stahl
Plain/unbeh Zincpl/verz



D	N	H	Box quantity/ Verpackung	Price/Preis €/1000 pcs/St	
				Plain/unbeh	Zincpl/verz
M6	10	50	200	900	950
M8	13	50	200	950	1020
M10	17	50	100	990	1150
M12	19	50	100	1200	1400
M14	22	50	50		2900
M16	24	50	50	1800	2300
M20	30	50	50	3400	3800
M24	36	50	50	4900	5700

Order ex./Best. ex.: Hexagon long nut/Sechskant langmutter Steel/Stahl M6 Plain/unbeh
Article ex./Artikelnr ex.: M6HM06

Coupling nut/Verbindungsmutter DIN 6334

Steel/Stahl Zincpl/verz



D	N	H	Box quantity/ Verpackung	Price/Preis €/1000 pcs/St	
				Plain/unbeh	Zincpl/verz
M6	10	18	200	300	310
M8	13	24	200		320
M10	17	30	100	590	600
M12	19	36	100	1170	1200
M16	24	48	50		2460
M20	30	60	25		13740
M24	36	72	Bulk/Grossverp.		19000
M27	41	81	Bulk/Grossverp.		20000

Order ex./Best. ex.: DIN 6334 Steel/Stahl M6 Zincpl/verz
Article ex./Artikelnr ex.: 6334061

Hexagon long nut/ Sechskant langmutter U6HM

UNC-thread/UNC-Gewinde
Steel/Stahl



D	N (mm)	N (tum)	H	Box quantity/ Verpackung	Price/Preis €/1000 pcs/St
					Plain/unbeh
3/8	14,3	9/16	50	100	3162

Order ex./Best. ex.: Hexagon long nut/Sechskant langmutter Steel/Stahl 3/8 UNC Plain/unbeh
Article ex./Artikelnr ex.: U6HM38

DIN 6330

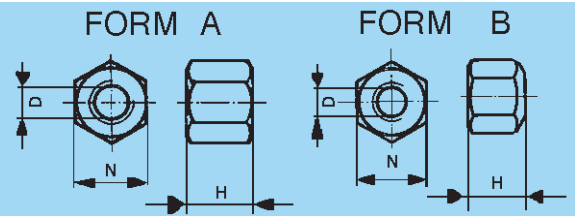

Form A and/und B
Steel/Stahl Class/Klasse 6/10

D	N	H	Box quantity/ Verpackung	Price/Preis €/1000 pcs/St		
				FORM A Class/Klasse 6	FORM B Class/Klasse 6	FORM B Class/Klasse 10
M8	13	12	100	650	650	1330
M10	16	15	100	730	730	1610
M12	18	18	50	850	850	2240
M14	22	21	25	1200	2700	3850
M16	24	24	25	1400	1400	
M18	27	27	25	7600	4905	6650
M20	30	30	25	4500	4500	8750
M22	32	33	25	6900	6900	10500
M24	36	36	10	7800	7800	12600
M27	41	40	Bulk/Grossverp.	13275	13275	21000
M30	46	45	Bulk/Grossverp.	17775	17775	28000
M36	55	54	Bulk/Grossverp.			47600

Order ex./Best. ex.: DIN 6330 A Steel/Stahl M8
Article ex./Artikelnr ex.: 6330A608

DIN 6331

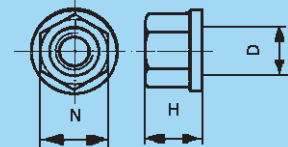

Steel/Stahl Class/Klasse 10

D	N	H	Box quantity/ Verpackung	Price/Preis €/1000 pcs/St
M8	13	12	50	3735
M10	16	15	50	5738
M12	18	18	25	6863
M14	22	21	10	13500
M16	24	24	10	11250
M18	27	27	Bulk/Grossverp.	14850
M20	30	30	Bulk/Grossverp.	14850
M22	32	33	Bulk/Grossverp.	30375
M24	36	36	Bulk/Grossverp.	27225
M27	41	40	Bulk/Grossverp.	65250
M30	46	45	Bulk/Grossverp.	46350

Order ex./Best. ex.: DIN 6331 Class/Klasse 10 M8
Article ex./Artikelnr ex.: 63311008

Tee nut/Einschlagmutter

Steel/Stahl
Plain/unbeh Zincpl/verz

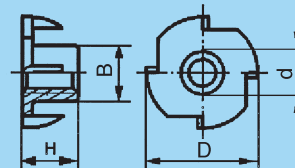

d	D	H	B	Box quantity/ Verpackung	Price/Preis €/1000 pcs/St	
					Plain/unbeh	Zincpl/verz
M3	13	5,3	3,8	500	503	507
M4	15	8	5,3	500	75	77
M5	17	8	6,2	500	113	117
M6	19	9	7,7	500	117	120
M8	22	11	9,5	200	156	173
M10	25,5	13	12	200	282	398
M12	27	15	14	200		1960

Order ex./Best. ex.: Tee nut/Einschlagmutter Steel/Stahl M3 Plain/unbeh
Article ex./Artikelnr ex.: TN03

DIN 466/DIN 467

Steel/Stahl
Class/Klasse 5 Zincpl/verz

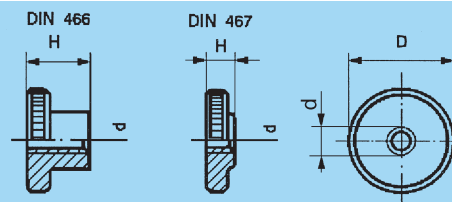

d	D	H		Box quantity/ Verpackung	Price/Preis €/1000 pcs/St	
		DIN 466	DIN 467		DIN 466	DIN 467
M2	9	5,3	2,5	100	1790	1790
M2,3	10	6	3	100	2465	2465
M2,5	11	6,5	3	100	2633	2465
M2,6	11	7	3	100	2633	2465
M3	12	7,5	3	100	504	417
M3,5	14	8,5	3,5	100	1553	1553
M4	16	9,5	4	100	797	756
M5	20	11,5	5	100	1229	851
M6	24	15	6	100	2127	1364
M8	30	18	8	50	3578	2565
M10	36	23	10	50	5900	4199

Order ex./Best. ex.: DIN 466 Steel/Stahl M2 Zincpl/verz
Article ex./Artikelnr ex.: 4660201

Cage nut/Käfigmutter

Steel/Stahl SMG Zincl/verz

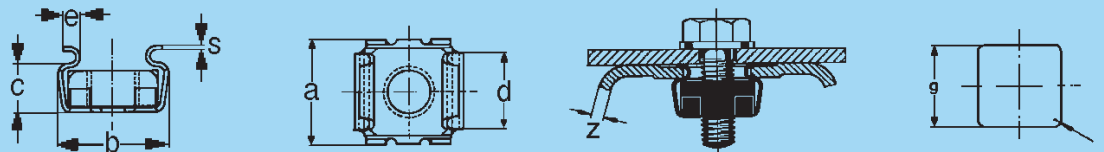
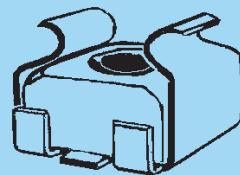

Thread/ Gewinde	Code/ Kod	a	b	c	d	e	s	g-0,5	r	z	Price/Preis €/1000 pcs/St
M4	4	13,1	13,5	4,6	8,7	2,3	0,5	9,5	0,8	0,7-1,7	327
M5	6	13,4	13,9	6,4	8,8	2,3	0,5	9,5	0,8	0,7-1,7	306
M6	6	13,4	13,9	6,4	8,8	2,3	0,5	9,5	0,8	0,7-1,7	327
M8	6	16,6	17,8	7,4	11,4	3,4	0,6	12,5	1,2	0,7-1,7	491
M4	8	13,1	13,5	4,6	8,7	2,3	0,5	9,5	0,8	1,8-2,6	327
M5	8	13,1	13,7	6,3	8,8	2,3	0,5	9,5	0,8	1,8-2,6	306
M6	8	13,1	13,7	6,3	8,8	2,3	0,5	9,5	0,8	1,8-2,6	327
M8	8	16,6	17,8	7,4	11,4	3,4	0,6	12,5	1,2	1,8-2,6	491
M10	8	16,6	17,8	7,4	11,4	3,4	0,6	12,5	1,2	1,8-2,6	816

Order ex./Best. ex.: SMG M4-4 Zincl/verz Article ex./Artikelnr ex.: SMG441 Box quantity/Verpackung: 1000 pcs/St.

MC/SMC

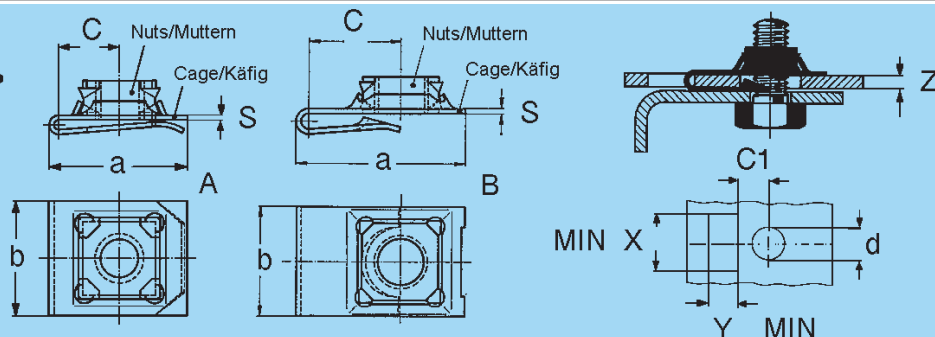

Steel/Stahl
Yellow ZPL/
gelbverz

Type	Thread/ Gewinde	a	b	c	s	c1	d	x	y	z	Performance/ Ausführung	Price/Preis €/1000 pcs/St
MC5648	M4	17,1	12,0	8,0	0,6	8,0	6,0	12,4	8,5	1,7-2,8	A	1000
SMC6238	M5	23,0	16,0	11,5	1,5	11,5	8,0	16,4	-	3,0-3,4	B	1350
MC5678	M6	17,1	14,0	7,0	0,6	7,0	8,0	14,4	-	2,2-3,0	A	1100
SMC5535	M6	24,5	15,8	13,3	0,7	13,3	10,2	16,2	8,0	0,7-2,0	B	1350
MC5988	M8	26,5	18,0	14,9	0,7	14,9	10,2	18,4	8,0	0,7-2,0	A	1350

Order ex./Best. ex.: MC 5648 M8 Yellow ZPL/gelbverz
Article ex./Artikelnr ex.: MC56483

Box quantity/Verpackung: 1000 pcs/St.

CV

Steel/Stahl
Zincl/verz

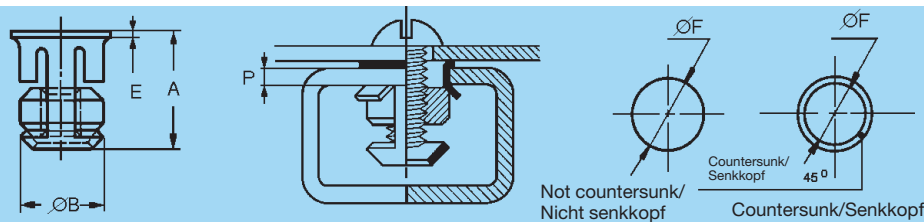

Thread/ Gewinde Ø mm	P=Sheet thickness/Blechdicke mm		Countersunk/ Senkkopf no/nr	Det.no/ Det.nr	A	Ø B ±0,1	E	Ø F	Price/Preis €/1000 pcs/St
	Not countersunk/ Nicht Senkkopf	Countersunk/ Senkkopf							
M4	0,7-3	1,2-3,5	0,75	CV4822	9,2	7	0,5	7,2	1100
M4	0,7-4	1,5-5	1	CV4824	13	9,9	0,6	10,1	1150
M5	0,7-4	1,5-5	1	CV4825	13	9,9	0,6	10,1	1250
M6	0,7-4	1,5-5	1	CV4826	13	9,9	0,6	10,1	1300
M8	1,0-6	1,8-7	1,5	CV4828	18,2	12,9	0,9	13,2	1550

Order ex./Best. ex.: CV 4822 M4 Zincl/verz
Article ex./Artikelnr ex.: CV4822

Box quantity/Verpackung: 1000 pcs/St.

SNU speednut/Schnappmutter

For/für Self tapping Screw/Blechschauben

Steel/Stahl Plain/unbeh Zinopl/verz

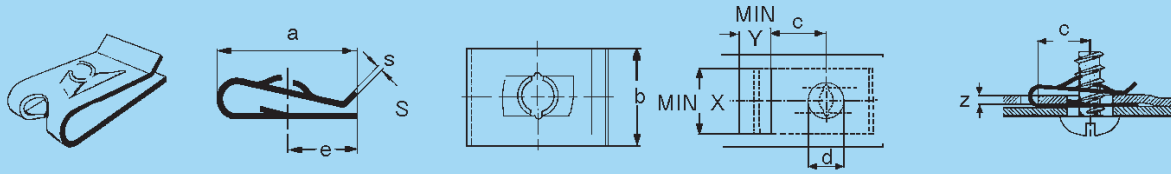

Price/Preis €/1000 pcs/St													
Screw/ Schraube	z	Det.no/ Det.nr	a	b	c	e	s	d	x	y	Performance Ausführung	Plain/ unbeh	Zinopl/ verz
2,9	0,7-1,2	SNU 1812 N	11,1	7,9	4,8	5,0	0,5	4,8	8,3	5,5	S	93	
3,5	0,7-1,6	SNU 1219 G	16,4	11,0	6,7	7,9	0,6	6,0	11,4	6,1	D		134
4,2	0,6-1,0	SNU 1864 G	13,9	12,7	5,6	6,4	0,6	7,2	13,0	6,4	F		134
4,2	0,8-1,2	SNU 5814 G	15,1	10,3	8,4	5,6	0,5	5,0	-	-	A		174
4,2	0,7-1,6	SNU 1561 N	24,6	11,1	15,0	7,9	0,6	7,2	11,4	10,7	D	174	
4,2	0,7-1,6	SNU 0536 G	16,5	11,0	6,7	7,9	0,6	7,2	11,4	7,6	D	113	
4,2	1,2-1,6	SNU 1686 G	13,9	12,7	5,6	6,4	0,6	7,2	13,0	7,1	F		134
4,2	1,6-2,0	SNU 6601 G	10,4	8,7	4,2	4,5	0,6	6,6	-	-	A		134
4,2	2,0-2,8	SNU 2569 G	16,3	11,1	6,7	7,9	0,6	7,2	11,4	7,6	D		266
4,2	3,2-3,6	SNU 1907 G	17,2	11,1	6,8	7,9	0,6	6,4	-	-	B		174
4,2	4,0-5,0	SNU 5219 G	16,4	11,1	5,3	7,9	0,6	6,4	-	-	B		204
4,8	0,9-1,6	SNU 3275 G	12,2	16,0	5,5	3,5	0,7	8,0	-	-	E		123
4,8	0,9-2,0	SNU 0537 G	19,8	12,7	7,9	9,6	0,7	8,0	12,9	9,4	S		144
4,8	3,0-3,8	SNU 5270 G	20,0	16,0	8,0	9,3	0,7	8,0	-	-	J		225
4,8	6,0-6,4	SNU 2012 G	22,2	17,5	10,3	7,9	0,7	8,0	-	-	F		306
5,5	0,9-2,6	SNU 0538 N	26,2	15,1	11,1	12,4	0,8	10,0	15,4	9,9	D	204	
5,5	3,0-3,5	SNU 5508 G	26,2	15,1	11,1	12,4	0,8	10,0	-	-	D		306
6,3	2,3-2,8	SNU 6527 G	16,7	19,0	7,9	6,6	0,9	9,5	-	-	J		234
6,3	0,7-2,0	SNU 6304 G	25,0	15,0	12,5	10,5	0,8	8,7	15,5	14,0	S		306

Order ex./Best. ex.: SNU 1812
Article ex./Artikelnr ex.: SNU1812

Box quantity/Verpackung: 1000 pcs/St.

SNJ Speednut/Schnappmutter

For/für
Self tapping screw/
Blechschauben
Steel/Stahl
Yellow ZPL/gelbverz

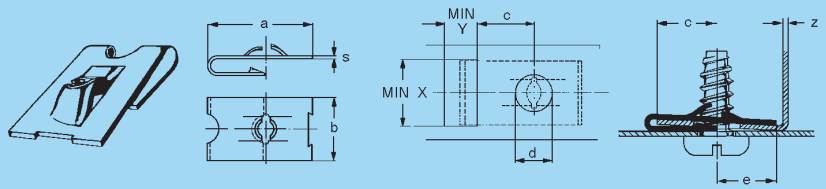

Screw/ z Schraube	Det.no/ Det.nr	a	b	c	e	s	d	x	y	Price/Preis €/1000 pcs/St
3,5 1,2-1,6	SNJ 1198/6 G	16,6	11,1	7,1	8,0	0,6	6,1	11,4	4,1	300
3,5 2,4-2,6	SNJ 5681 G	16,6	9,7	6,3	8,1	0,6	6,4	10,3	6,4	280
4,2 0,7-1,2	SNJ 0116/5 G	16,7	11,1	7,1	8,0	0,6	7,1	11,4	5,6	280
4,2 1,4-1,8	SNJ 0116/6 G	16,6	11,1	7,1	8,0	0,6	7,1	11,4	5,6	300
4,8 0,7-1,2	SNJ 0117/5 G	19,8	12,7	8,9	9,3	0,7	7,9	13,0	6,4	350

Order ex./Best. ex.: SNJ 1198/6 Yellow ZPL/gelbverz
Article ex./Artikelnr ex.: SNJ119863

Box quantity/Verpackung: 1000 pcs/St.

SNP Speednut/Schnappmutter

For/für Self tapping screw/
Blechschauben
Steel/Stahl M-thread/M-gewinde
Plain/unbeh Yellow ZPL/gelbverz

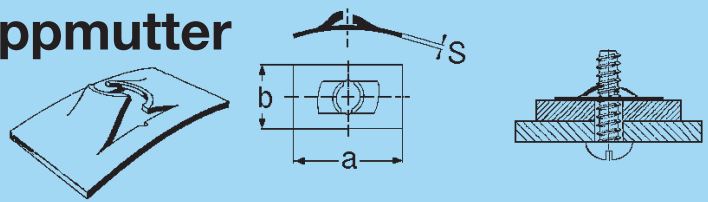

Screw/ Schraube	Det.no/ Det.nr	a	b	s	Price/Preis €/1000 pcs/St	
					Plain/unbeh	Yellow ZPL/gelbverz
4,2	SNP 0176 G	15,2	9,5	0,6		300
4,8	SNP 0177 G	16,7	10,3	0,7		250
5,5	SNP 0178 N	17,5	11,1	0,8	250	250
M4	SNP 5021 G	12,0	8,7	0,4		220
M5	SNP 5367 N	16,7	10,3	0,4	123	
M6	SNP 5373 N	17,5	11,1	0,5	134	

Order ex./Best. ex.: SNP 0176 Yellow ZPL/gelbverz
Article ex./Artikelnr ex.: SNP01763

Box quantity/Verpackung: 1000 pcs/St.

NU Speednut/ Schnappmutter

For/für
Self tapping screw/Blechschauben
Steel/Stahl Plain/unbeh

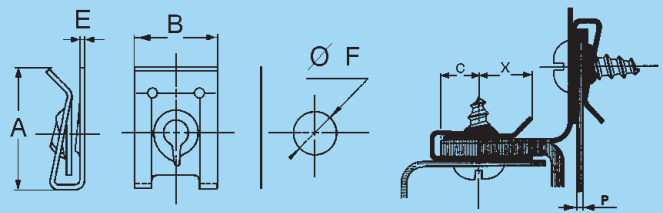

Thread/ Gewinde Ø mm	P= Sheet thickness/ Blechdicke mm	Det.no/ Det.nr	A	B	X	C MAX	E	F	Price/Preis €/1000 pcs/St
Ø 3,5	0,5-4	NU 923 N	20	14	10	8,8	0,5	6	850
Ø 4,2	0,5-4	NU 920 N	20	14	10	8,8	0,5	7	1050
Ø 4,8	0,5-4	NU 921 N	20	14	10	8,8	0,6	7	830

Order ex./Best. ex.: NU 923 N
Article ex./Artikelnr ex.: NU923

Box quantity/Verpackung: 1000 pcs/St.

Speed nut/ Schnappmutter

M-thread/M-Gewinde

Steel/Stahl Zinopl/verz

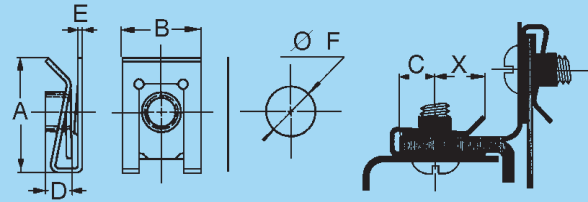

Thread/ Gewinde Ø mm	P=Sheet thickness/ Blechdicke	Det.no/ Det.nr mm	A	B	D	X	C MAX	E	F	Price/Preis €/1000 pcs/St
M5	0,5-4	NUT 955	20,4	14	5,2	9	10	0,6	7,5	918
M6	0,5-4	NUT 956	20,4	15	6,5	10	11	0,7	8,5	969
M8	0,5-4	NUT 958	24,6	17	7,5	9,8	12	1,0	11,6	1122

Order ex./Best. ex.: NUT 955
Article ex./Artikelnr ex.: NUT955

Box quantity/Verpackung: 1000 pcs/St.

Hex distance nut/ 6-kant Distanzmutter



Steel/Stahl Zinopl/verz

D	H	N	Box quantity/Verpackung	Price/Preis €/1000 pcs/St
M5	10	8	200	536
M5	15	8	200	612
M5	20	8	200	725
M5	25	8	200	779
M6	10	10	200	549
M6	15	10	200	639
M6	20	10	100	734
M6	25	10	100	788
M6	30	10	100	927
M6	35	10	100	1152
M6	40	10	100	1260
M6	50	10	100	2286
M8	15	13	100	878
M8	20	13	100	1040
M8	25	11	100	1085
M8	25	13	100	1278
M8	30	11	100	1242
M8	30	13	100	1481
M8	40	13	100	1971
M8	50	13	50	2988
M8	60	13	50	3636
M10	20	17	50	1458
M10	25	17	50	1823
M10	30	13	100	1643
M10	30	17	50	2183
M10	40	13	50	2192
M10	40	17	50	2911
M10	50	17	50	3636
M10	60	17	25	4496
M10	70	17	25	5283
M12	25	19	50	2300
M12	30	17	50	2687
M12	30	19	50	2831
M12	40	17	50	3407
M12	40	19	50	3735
M12	50	17	25	4239
M12	50	19	25	4689
M12	60	19	25	5616
M12	70	19	25	6489
M14	40	22	50	4496
M14	50	22	25	5517
M16	30	24	25	4059
M16	40	22	50	4941
M16	40	24	25	5391
M16	50	22	25	6206
M16	50	24	25	6768
M16	60	24	25	8901

Order ex./Best. ex.: Hex distance nut/6-kant Distanzmutter M5 x 10 x 8 Zinopl/verz
Article ex./Artikelnr ex.: HDN05010081

Hex distance nut/ 6-kant Distanzmutter

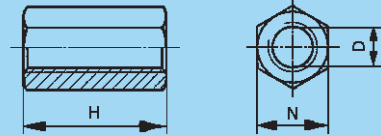

Steel/Stahl Zincpl/verz

D	H	N	Box quantity/Verpackung	Price/Preis €/1000 pcs/St
M18	50	27	25	9284
M20	40	30	25	8199
M20	50	27	25	9284
M20	50	30	25	10202
M20	60	30	25	12006
M22	50	32	25	11457
M24	40	36	25	10778
M24	50	36	25	13158
M24	60	36	25	15795
M27	50	41	25	17325
M30	50	41	25	17325
M30	50	46	25	24440
M30	60	46	25	29327
M36	60	55	25	44910

Order ex./Best. ex.: Hex distance nut/6-kant Distanzmutter M18 x 50 x 27 Zincpl/verz
Article ex./Artikelnr ex.: HDN18050271

**Delivery yesterday ... impossible,
but we promise to utilize every second
when you need articles at once!**



Round distance nut/ Rund Distanzmutter

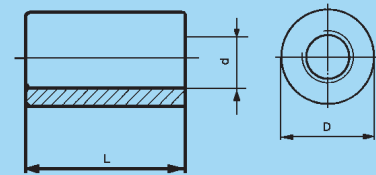

Steel/Stahl Zinopl/verz

d	L	D	Box quantity/Verpackung	Price/Preis €/1000 pcs/St
M4	15	7	200	644
M4	20	7	200	720
M5	20	8	200	680
M5	25	8	200	738
M6	10	10	200	936
M6	15	10	200	545
M6	20	10	100	626
M6	25	10	100	675
M6	30	10	100	783
M6	35	10	100	1004
M6	40	10	100	1076
M6	50	10	100	1985
M8	15	11	100	626
M8	20	11	100	675
M8	25	11	100	725
M8	30	11	100	828
M8	35	11	100	1125
M8	40	11	100	1202
M8	50	11	100	2007
M10	20	13	100	876
M10	25	13	100	1040
M10	30	13	100	1125
M10	35	13	100	1341
M10	40	13	100	1566
M10	50	13	50	2435
M10	60	13	50	2997
M12	20	15	100	1031
M12	25	15	100	1139
M12	30	15	100	1629
M12	35	15	100	1931
M12	40	15	100	2255
M12	50	15	50	3335
M12	60	15	50	4266
M16	40	22	50	4487
M16	40	25	25	4991
M16	50	22	25	5657
M16	50	25	25	6269
M16	60	22	25	7443
M16	60	25	25	8343
M16	70	25	25	9653
M16	80	25	25	11007
M20	40	28	25	7821
M20	50	28	25	9734
M20	60	28	25	11682
M20	80	28	25	17055

Order ex./Best. ex.: Round distance nut/Rund Distanzmutter M4 x 15 x 7 Zinopl/verz
Article ex./Artikelnr ex.: RDN04015071

Pressnut Kalei/Setzmutter

KALEI® /BULEI
Case hardened/einsatzgehärtet
Steel/Stahl Zinopl/verz

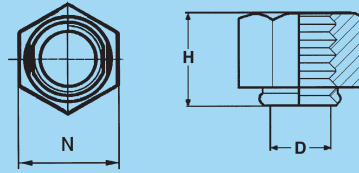

D	N	H	min Sheet thickness/ Blechdicke	Box quantity/ Verpackung	Price/Preis €/1000 pcs/St	
					KALEI	BULEI
M2,5	5,5	3,0	1	500	673	
M3	5,5	3,0	1	500	567	
M4	7,0	3,2	1	500	573	
M5	8,0	4,0	1	500	750	
M6	10,0	5,0	1	250	921	
M8	13,0	6,5	2	250	1204	1100
M10	15,0	8,0	2	250	2195	1900
M12	17,0	10,0	3	250	2856	
M16	22,0	13,0	3	250	7175	
M20	27,0	16,0	4	250	10750	

Order ex./Best. ex.: Pressnut Kalei/Setzmutter Kalei M2,5 Zinopl/verz
Article ex./Artikelnr ex.: KALEI0251

Rivet nut/Nietmutter

Anchor ARB BN 196
Steel/Stahl Zinopl/verz

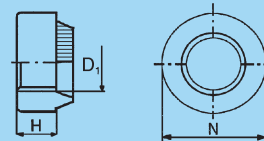

D	H	N	Material thickness/ Material dicke	Box quantity/ Verpackung	Price/Preis €/1000 pcs/St
M3	3,2	7,9	0,5-1,6	100	519
M3	3,2	7,9	1,7-2,4	100	651
M3	3,2	7,9	2,5-3,7	100	822
M3	3,2	7,9	3,8-5	100	693
M4	3,8	9,5	0,5-1,6	100	561
M4	3,8	9,5	1,7-2,4	100	576
M4	3,8	9,5	2,5-3,7	100	591
M4	3,8	9,5	3,8-5	100	885
M5	4,4	11,1	0,5-1,6	100	606
M5	4,4	11,1	1,7-2,4	100	600
M5	4,4	11,1	2,5-3,7	100	1008
M5	4,4	11,1	3,8-5	100	1026
M6	5,7	12,7	0,5-1,6	100	690
M6	5,7	12,7	1,7-2,4	100	717
M6	5,7	12,7	2,5-3,7	100	726
M6	5,7	12,7	3,8-5	100	906
M8	6,4	15,9	0,5-2	100	1134
M8	6,4	15,9	2,1-3,7	100	1596
M8	6,4	15,9	3,8-5	100	1566
M10	7,6	19,1	0,5-2	100	1986
M10	7,6	19,1	2,1-3,7	100	1974
M10	7,6	19,1	3,8-5	100	2148
M12	10,2	25,4	0,5-3	100	4800

Order ex./Best. ex.: Rivet nut/Nietmutter M3 Zinopl/verz Anchor ARB for 0,5-1,6 mm/matr. 0,5-1,6 mm
Article ex./Artikelnr ex.: NM03051

Hexagon thin nut/ Sechskantmutter niedrige Form

UNC-thread/Gewinde ANSI B 18.2.2

Steel/Stahl Plain/unbeh Zinopl/verz HDG/feuerverz

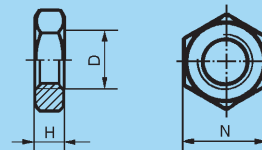

D	N (mm)	N (tum)	H	Box quantity/ Verpackung	Price/Preis €/1000 pcs/St		
					Plain/unbeh	Zinopl/verz	HDG/feuerverz
1/4	11,1	7/16	4,0	200		149	
5/16	12,7	1/2	4,8	200		165	
3/8	14,3	9/16	5,6	200		480	
1/2	19	3/4	7,9	200		565	
5/8	23,8	15/16	9,5	200		1200	
3/4	28,6	1 1/8	10,7	100		1900	2200
7/8	33,3	1 5/16	12,3	25		3900	
1"	38,1	1 1/2	13,9	25	5900	6800	
1 1/2	57,1	2 1/2	21,4			16200	

Order ex./Best. ex.: Steel/Stahl 1/4 UNC Zinopl/verz Hexagon thin nut/Sechskantmutter niedrige Form

Article ex./Artikelnr ex.: 439U141

Combinut/Kombimutter

With lock washer/mit Zahnscheiben BN 1364

Steel/Stahl Zinopl/verz

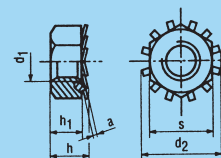

d ₁	d ₂	h	h ₁	a	s	Box quantity/ Verpackung	Price/Preis €/1000 pcs/St
M3	6,8	3,4	2,4	0,45	5,5	100	124
M4	8,5	4,25	3,2	0,45	7	100	134
M5	9,5	5,25	4	0,5	8	100	138
M6	12	6,45	5	0,6	10	100	144
M8	15,5	8,25	6,5	0,8	13	100	225
M10	20,1	9,8	8	0,9	17	100	1160

Order ex./Best. ex.: Combinut/Kombimutter M3 With lock washer/mit Zahnscheiben

Article ex./Artikelnr ex.: BN1364031

Self locking counter nut/ Sicherungsmutter DIN 7967

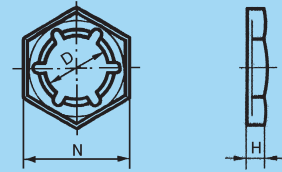

Plain/unbeh Zinclpl/verz

D for thread / für Gewinde	N	H	Box quantity/ Verpackung	Art.no/Art.nr Plain/unbeh	Art.no/Art.nr Zinclpl/verz	Price/Preis €/1000 pcs/St	
						Plain/unbeh	Zinclpl/verz
M6	10	3	1000	7967053	79670531	174	197
M8	13	3,5	1000	7967069	79670691	225	255
M10	17	4	1000	7967086	79670861	270	320
M12	19	4,5	1000	7967104	79671041	359	417
M14	22	5	500	7967120	79671201	833	923
M16	24	5	500	7967141	79671411	539	630
M20	30	6	500	7967176	79671761	732	900
M22	32	6	200	7967196	79671961	1823	1980
M24	36	7	200	7967210	79672101	1328	1575
M27	41	7	100	7967242	79672421	2610	2970
M30	46	8	100	7967266	79672661	3015	3465
M33	50	8	50	7967298	79672981	4005	4635
M36	55	9	50	7967322	79673221	9788	10575
M42	65	11	50	7967376	79673791	14400	15525
M48	75	14	25	7967439	79674391	20925	22950

Order ex./Best. ex.: DIN 7967 Self locking counter nut/Sicherungsmutter Steel/Stahl M6 Zinclpl/verz
Article ex./Artikelnr ex.: 7967053

Pressnut/Setzmutter

BN 201
Case hardened/einsatzgehärtet
Steel/Stahl Zinclpl/verz

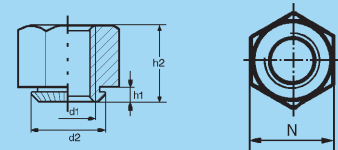

D	N	h1	Min sheet thickness/ Blechdicke	H	Box quantity/ Verpackung	Art.no/Art.nr	Price/Preis €/1000 pcs/St
M2	5,5	0,9	1	3	100	PM020091	729
M2,5	5,5	0,9	1	3	100	PM025091	561
M3	5,5	0,9	1	3	100	PM030091	372
M3	5,5	1,8	2	3	100	PM030181	663
M4	7	0,9	1	3,2	100	PM040091	390
M4	7	1,8	2	4,5	100	PM040181	471
M5	8	0,9	1	4	100	PM050091	558
M5	8	1,8	2	5	100	PM050181	639
M6	10	0,9	1	5	100	PM060091	738
M6	10	1,8	2	5	100	PM060181	708
M8	13	1,8	2	6,5	100	PM080181	852
M10	15	1,8	2	8	100	PM100181	1416
M12	17	2,8	3	10	100	PM120281	2076
M16	22	2,4	3	13	100	PM160241	5610
M20	27	3,9	4	16	100	PM200391	8160

Order ex./Best. ex.: Pressnut/Setzmutter M2 h1=0,9 Zinclpl/verz
Article ex./Artikelnr ex.: PM020091

DIN 981

Steel/Stahl
Plain/unbeh

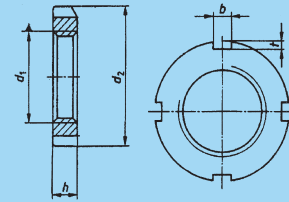

KM	d1 (M)	d2 h 13	h h 13	b js 14	t	Box quantity Verpackung	Price/Preis €/1000 pcs/St
0	10 x 0,75	18	4	3	2	250	960
1	12 x 1	22	4	3	2	250	1190
2	12 x 1	25	5	4	2	250	1290
3	17 x 1	28	5	4	2	250	1430
4	20 x 1	32	6	4	2	250	1650
5	25 x 1,5	38	7	5	2	100	2290
6	30 x 1,5	45	7	5	2	100	2790
7	35 x 1,5	52	8	5	2	100	3860
8	40 x 1,5	58	9	6	2,5	100	4700
9	45 x 1,5	65	10	6	2,5	100	6070
10	50 x 1,5	70	11	6	2,5	50	7230
11	55 x 2	75	11	7	3	50	8730
12	60 x 2	80	11	7	3	50	9580
13	65 x 2	85	12	7	3	50	12880
14	70 x 2	92	12	8	4	24	14330
15	75 x 2	98	13	8	4	25	16300
16	80 x 2	105	15	8	4	25	19140
17	85 x 2	110	16	8	4	15	21510
18	90 x 2	120	16	10	4	15	23820
19	95 x 2	125	17	10	4	15	26470
20	100 x 2	130	18	10	4	10	30320
21	105 x 2	140	18	12	5	10	37710
22	110 x 2	145	19	12	5	5	39330
23	115 x 2	150	19	12	5	5	44210
24	120 x 2	155	20	12	5	5	44210
25	125 x 2	160	21	12	5	5	51260
26	130 x 2	165	21	12	5	5	51260
27	135 x 2	175	22	14	5	5	56390
28	140 x 2	180	22	14	5	5	69260
29	145 x 2	190	24	14	6	5	73080
30	150 x 2	195	24	14	6	4	77780
31	155 x 3	200	25	16	7	3	81530
32	160 x 3	210	25	16	7	3	101000
33	165 x 3	210	26	16	7	3	103150
34	170 x 3	220	26	16	7	3	120190
36	180 x 3	230	27	18	8	3	127500
38	190 x 3	240	28	18	8	3	128150
40	200 x 3	250	29	18	8	3	131600

Order ex./Best. ex.: DIN 981 Steel/Stahl KM0 M10 x 0,75 Plain/unbeh
Article ex./Artikelnr ex.: 981010075

Locknut CRN

With self locking ring
Steel/Staal Zincpl/verz

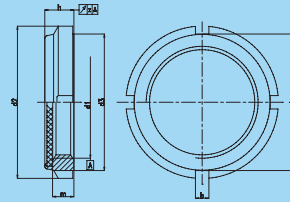

CRN	d ₁ (M)	d ₂ h 11	d ₃ =t -0,5	h max	b H 13	No.	Box quantity/ Verpackung	Price/Preis €/1000 pcs/St
0	10 x 0,75	18	15	7,6	3	4	250	1420
1	12 x 1	21	18	7,6	3	4	250	1560
2	15 x 1	24	21	8,6	4	4	250	1620
3	17 x 1	28	24	8,7	4	4	250	1970
4	20 x 1	32	27	9,6	4	4	250	2290
5	25 x 1,5	38	33	10,5	5	4	100	3140
6	30 x 1,5	44	38	10,7	5	4	100	3820
7	35 x 1,5	50	44	11,3	5	4	100	4740
8	40 x 1,5	56	50	12,3	6	4	100	5940
9	45 x 1,5	62	55	12,3	6	4	100	7250
10	50 x 1,5	68	61	12,9	6	4	50	8520
11	55 x 2	75	68	13,4	7	6	50	11860
12	60 x 2	80	73	13,4	7	6	50	12920
13	65 x 2	85	77	14,5	7	6	50	16050
14	70 x 2	92	84	14,5	8	6	25	20280
15	75 x 2	98	89	15,5	8	6	25	20930
16	80 x 2	105	96	16,5	10	8	25	27650
17	85 x 2	110	100	17,5	10	8	15	30600
18	90 x 2	120	110	17,7	10	8	15	33880
19	95 x 2	125	115	18,7	10	8	15	37630
20	100 x 2	130	120	19,7	10	8	10	40550

Order ex./Best. ex.: Locknut CRN 0 M10 x 0,75 Zincpl/Verz
Article ex./Artikelnr ex.: 9810100751CRN

Locknut CRP

With self locking ring
Steel/Staal Zincpl/verz

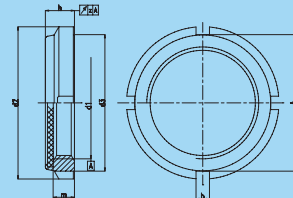

CRP	d ₁ (M)	d ₂ h 11	d ₃ =t -0,5	h max	b H 13	No.	Box quantity/ Verpackung	Price/Preis €/1000 pcs/St
4	20 X 1	32	27	13,2	4	4	250	2360
5	25 X 1,5	38	33	14,2	5	4	100	3580
6	30 X 1,5	44	38	14,2	5	4	100	4320
7	35 X 1,5	50	44	15,2	5	4	100	5450
8	40 X 1,5	56	50	16,7	6	4	100	6830
9	45 X 1,5	62	55	16,7	6	4	100	8300
10	50 X 1,5	68	61	18,7	6	4	50	10400
11	55 X 2	75	68	18,7	7	6	50	14500
12	60 X 2	80	73	18,7	7	6	50	16150
13	65 X 2	85	77	19,7	7	6	50	17980
14	70 X 2	92	84	19,7	8	6	25	22900
15	75 X 2	98	89	20,7	8	6	25	23680
16	80 X 2	105	96	20,7	10	8	25	29600
17	85 X 2	110	100	21,7	10	8	15	32550
18	90 X 2	120	110	21,7	10	8	15	36450
19	95 X 2	125	115	22,2	10	8	15	40550
20	100 X 2	130	120	24,2	10	8	10	44080

Order ex./Best. ex.: Locknut CRP 4 M20 x 1 Zincpl/Verz
Article ex./Artikelnr ex.: 9810201001CRP